

Mitchell

UPL0117-WM

THIS PRICE SHEET
SUPERSEDES ALL OTHER
PREVIOUS SHEETS

WALL MOUNTED PRICE LIST

08 Series Wall Systems - Against Wall - Set-In Wall - Half-in/Half-Out
Table Only Systems - Single Depth - Double Depth - Triple Depth
Quad Depth - Replacement Tables, Benches and Cabinets



MITCHELL

FURNITURE SYSTEMS

1700 W. St. Paul Avenue Milwaukee, WI 53201
www.mitchell-tables.com sales@mitchell-tables.com
(Phone) 800-290-5960 or 414-342-3111 (Fax) 414-342-4239

TERMS OF SALE - 30 days net to trade of established credit. No anticipation, no dating, 1½% per month service charge on overdue accounts. Where no credit is established, arrangements must be made regarding terms. All prices are F.O.B. Milwaukee, Wisconsin, without freight allowances.

ORDERS - All orders and contracts are subject to acceptance at Milwaukee, Wisconsin, and are contingent upon fires, strikes, accidents or other causes beyond our control. Shipments are made at purchaser's risk. All prices are quoted for immediate acceptance and are subject to change without notice. Prices prevailing at time of shipment must apply. Clerical errors are subject to correction.

PHONE ORDERS - "Confirmation" must follow immediately. Duplicate orders not marked or identified as "confirmation" are the responsibility of the customer.

ACKNOWLEDGEMENTS - Every order is acknowledged. Orders are manufactured and invoiced based upon the information in the acknowledgement. If there is any discrepancy, the dealer must notify Mitchell Furniture Systems within 5 working days. Orders are accepted by Mitchell Furniture Systems per terms herein and on the acknowledgement. Mitchell Furniture Systems rejects any terms and conditions contained in any customer purchase orders or other business forms which are different from the terms stated herein and on the acknowledgement.

SHIPMENT DAMAGE CLAIMS - All shipments should be carefully inspected by the consignee before acceptance and the delivering carrier should be requested to record any damage or shortage on the delivery receipt before the consignee signs it. If further damage is found after delivery, immediate inspection by the delivering carrier should be requested. Notification of concealed damages must be made to the delivering carrier within 15 days after delivery of merchandise. Carrier liability ceases after 15 days.

CAUTION: After obtaining a clear receipt for the shipment, the delivering carrier is no longer responsible for damage or shortages.

RETURNS - Merchandise returned will not be accepted without prior written consent of Mitchell Furniture Systems. After approval, returned merchandise must be shipped pre-paid and subject to 50% handling charge unless it is Mitchell's responsibility.

WARRANTY - Mitchell Furniture Systems warrants products purchased hereunder to be free of defects in materials and workmanship for a period of fifteen (15) years from the date of shipment. This warranty shall not apply in the event products are damaged as a result of misuse, abuse, neglect, accident, improper application, modification or repair by persons not authorized by Mitchell Furniture Systems, where products are damaged during shipment, or where date stamps on the products have been defaced, modified or removed. UNLESS CONSIDERED UNENFORCEABLE OR UNLAWFUL UNDER APPLICABLE LAW.

- a. ALL IMPLIED WARRANTIES, INCLUDING BUT NOT LIMITED TO WARRANTIES OF MERCHANTABILITY AND FITNESS FOR A PARTICULAR PURPOSE ARE HEREBY EXCLUDED.
- b. PURCHASER'S REMEDY, IF ANY, FOR ANY DEFECTIVE PRODUCTS SHALL BE LIMITED TO A REFUND, REPLACEMENT OR ADJUSTMENT BY MITCHELL FURNITURE SYSTEMS OF THE PRODUCTS AT MITCHELL FURNITURE SYSTEMS OPTION, AND SHALL IN NO EVENT INCLUDE DAMAGES OF ANY KIND, WHETHER INCIDENTAL, CONSEQUENTIAL OR OTHERWISE.

We reserve the right to make any changes in price, design and material specifications without notice.

Available Wall Mounted Dimensions

Table Length	Table Width	Table Height	Bench Length	Bench Width	Bench Height	Single Depth	Double Depth	Triple Depth	Quad Depth
14'	30"	29"	14'	12"	17"	5.81" D	11.37" D	16.93" D	22.43" D
13'-3"	28"	27"	13'-3"	10"					
12'			12'						
10'			10'						

Mitchell offers a variety of cabinet, table & bench sizes so you can choose what best fits your space requirements. We recommend that you contact your Mitchell dealer or home office professional to help with your decision making process.

Consider These Mitchell Wall Mounted Options

- ⇒ LAMINATE: 100's of standard color and wood grain choices are available from the Wilsonart and Pionite. These are available at no additional charge. Optional laminate choices may also be considered at an upcharge.
- ⇒ EDGE TREATMENT: DuraEdge™ is an extended bullnose polyvinyl specifically designed by Mitchell engineers to provide the best bump resistance and moisture barrier and is fastened 6" O.C. around the entire table. Lotz ArmorEdge™ the original sprayed-on Polyurea edging, is designed as a moisture barrier and is available as an option.
- ⇒ POWDER COAT: All steel table and bench components and cabinet are powder coated with a jet black satin finish.
- ⇒ ADA/WHEELCHAIR ACCESSIBLE: Mitchell offers ADA models. Please contact us to learn more about this option.
- ⇒ 10 FOOTER: As an option to fit limited space requirements, Mitchell offers a 10' unit. Please call for more information.
- ⇒ SPECIAL FLANGES: On occasion in replacement cases the rough opening is larger than our standard cabinet. In these cases we can provide wider flanges at a minimal upcharge. Please contact us to learn more about this option.
- ⇒ SPECIAL CONFIGURATIONS: Special recessed cabinet configurations can be discussed as an option if our standard units are not suitable for the space. Please contact us to learn more about this custom option.
- ⇒ A & E: Two and three dimensional space drawings are available if required. Mitchell also will provide product and engineering specifications along with LEED and environmental information.

SHIPPING: All wall systems are shipped completely assembled, cartoned and skidded. Cabinets stand upright when shipped and freight is carried by an independent furniture carrier to ensure the best possible transit directly to your site

WALL MOUNTED TABLE AND BENCH SYSTEMS

14' Tables & Benches w/Against Wall Cabinet, Vinyl DuraEdge™ on 3/4" Resin Wood

Standard Upgrades

"A" Against Wall Model	Description	Wt.	Price	DuraEdge™ & Plywood	Lotz ArmorEdge™ & MDF	Lotz ArmorEdge™ & Plywood
RD-08-14-3012-ASLP	Single Depth Cabinet w/Sloping Top Cap 14' L x 30" W Table and 2- 12" W Benches	615	\$6,054	\$169	\$337	\$678
RD-08-14-3012-AFLT	Single Depth Cabinet w/Flat Top Cap 14' L x 30" W Table and 2- 12" W Benches	615	\$6,054	\$169	\$337	\$678
RD-08-214-3012-ASLP	Double Depth Cabinet w/Sloping Top Cap 14' L x 2- 30" W Tables and 4- 12" W Benches	1110	\$10,961	\$337	\$675	\$1,355
RD-08-214-3012-AFLT	Double Depth Cabinet w/Flat Top Cap 14' L x 2- 30" W Tables and 4- 12" W Benches	1110	\$10,961	\$337	\$675	\$1,355
RD-08-314-3012-ASLP	Triple Depth Cabinet w/Sloping Top Cap 14' L x 3- 30" W Tables and 6- 12" W Benches	1585	\$16,762	\$506	\$1,011	\$2,568
RD-08-314-3012-AFLT	Triple Depth Cabinet w/Flat Top Cap 14' L x 3- 30" W Tables and 6- 12" W Benches	1585	\$16,762	\$506	\$1,011	\$2,568
RD-08-414-3012-ASLP	Quad Depth Cabinet w/Sloping Top Cap 14' L x 4- 30" W Tables and 8- 12" W Benches	2034	\$20,887	\$675	\$1,348	\$2,712
RD-08-414-3012-AFLT	Quad Depth Cabinet w/Flat Top Cap 14' L x 4- 30" W Tables and 8- 12" W Benches	2034	\$20,887	\$675	\$1,348	\$2,712

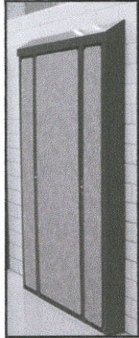

Single-Against Wall System

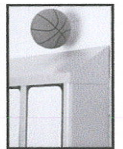

Double Depth Sloping Top Cap

RD-08-14-2812-ASLP	Single Depth Cabinet w/Sloping Top Cap 14' L x 28" W Table and 2- 12" W Benches	615	\$6,054	\$169	\$337	\$678
RD-08-14-2812-AFLT	Single Depth Cabinet w/Flat Top Cap	615	\$6,054	\$169	\$337	\$678
RD-08-214-2812-ASLP	Double Depth Cabinet w/Sloping Top Cap 14' L x 2- 28" W Tables and 4- 12" W Benches	1110	\$10,961	\$337	\$675	\$1,355
RD-08-214-2812-AFLT	Double Depth Cabinet w/Flat Top Cap 14' L x 2- 28" W Tables and 4- 12" W Benches	1110	\$10,961	\$337	\$675	\$1,355
RD-08-314-2812-ASLP	Triple Depth Cabinet w/Sloping Top Cap 14' L x 3- 28" W Tables and 6- 12" W Benches	1585	\$16,762	\$506	\$1,011	\$2,568
RD-08-314-2812-AFLT	Triple Depth Cabinet w/Flat Top Cap 14' L x 3- 28" W Tables and 6- 12" W Benches	1585	\$16,762	\$506	\$1,011	\$2,568
RD-08-414-2812-ASLP	Quad Depth Cabinet w/Sloping Top Cap 14' L x 4- 28" W Tables and 8- 12" W Benches	2034	\$20,887	\$675	\$1,348	\$2,712
RD-08-414-2812-AFLT	Quad Depth Cabinet w/Flat Top Cap 14' L x 4- 28" W Tables and 8- 12" W Benches	2034	\$20,887	\$675	\$1,348	\$2,712

RD-08-14-2810-ASLP	Single Depth Cabinet w/Sloping Top Cap 14' L x 28" W Table and 2- 10" W Benches	615	\$6,054	\$169	\$337	\$678
RD-08-14-2810-AFLT	Single Depth Cabinet w/Flat Top Cap 14' L x 28" W Table and 2- 10" W Benches	615	\$6,054	\$169	\$337	\$678
RD-08-214-2810-ASLP	Double Depth Cabinet w/Sloping Top Cap 14' L x 2- 28" W Tables and 4- 10" W Benches	1110	\$10,961	\$337	\$675	\$1,355
RD-08-214-2810-AFLT	Double Depth Cabinet w/Flat Top Cap 14' L x 2- 28" W Tables and 4- 10" W Benches	1110	\$10,961	\$337	\$675	\$1,355
RD-08-314-2810-ASLP	Triple Depth Cabinet w/Sloping Top Cap 14' L x 3- 28" W Tables and 6- 10" W Benches	1585	\$16,762	\$506	\$1,011	\$2,568
RD-08-314-2810-AFLT	Triple Depth Cabinet w/Flat Top Cap 14' L x 3- 28" W Tables and 6- 10" W Benches	1585	\$16,762	\$506	\$1,011	\$2,568
RD-08-414-2810-ASLP	Quad Depth Cabinet w/Sloping Top Cap 14' L x 4- 28" W Tables and 8- 10" W Benches	2034	\$20,887	\$675	\$1,348	\$2,712
RD-08-414-2810-AFLT	Quad Depth Cabinet w/Flat Top Cap 14' L x 4- 28" W Tables and 8- 10" W Benches	2034	\$20,887	\$675	\$1,348	\$2,712

Additional "A" Sizes

Mitchell offers these Against Wall sizes also:

RD-08-13 - 13'-3" L at same price as above
 RD-08-12 - 12' L at same price as above
 RD-08-10 - 10' L ask Mitchell for price info.

Filler Top Caps & Panels for "A" Wall Units

Description	Wt.	Price	Description	Wt.	Price
Filler Cap - Sngl. Depth	20	\$235	24" O.A.W. Filler Panel	64	\$408
Filler Cap - Dbl. Depth	25	\$306	30" O.A.W. Filler Panel	68	\$515
Filler Cap - Trpl. Depth	30	\$387	36" O.A.W. Filler Panel	72	\$614
Filler Cap - Quad Depth	35	Contact Factory	Panel Receiver Channels		\$218



Filler Panel & Filler Top Cap

WALL MOUNTED TABLE AND BENCH SYSTEMS

14' Tables & Benches w/Half-In/Half-Out Cabinet, Vinyl DuraEdge™ on 3/4" Resin Wood



Single Half-In/
Half-Out

"H" Half-In/Half-Out Model	Description	Wt.	Price	Standard Upgrades		
				DuraEdge™ & Plywood	Lotz ArmorEdge™ & MDF	Lotz ArmorEdge™ & Plywood
RD-08-14-3012-HSLP	Single Depth Cabinet w/Sloping Top Cap 14' L x 30" W Table and 2- 12" W Benches	615	\$6,054	\$169	\$337	\$678
RD-08-14-3012-HFLT	Single Depth Cabinet w/Flat Top Cap 14' L x 30" W Table and 2- 12" W Benches	615	\$6,054	\$169	\$337	\$678
RD-08-214-3012-HSLP	Double Depth Cabinet w/Sloping Top Cap 14' L x 2- 30" W Tables and 4- 12" W Benches	1110	\$10,961	\$337	\$675	\$1,355
RD-08-214-3012-HFLT	Double Depth Cabinet w/Flat Top Cap 14' L x 2- 30" W Tables and 4- 12" W Benches	1110	\$10,961	\$337	\$675	\$1,355
RD-08-314-3012-HSLP	Triple Depth Cabinet w/Sloping Top Cap 14' L x 3- 30" W Tables and 6- 12" W Benches	1585	\$16,762	\$506	\$1,011	\$2,568
RD-08-314-3012-HFLT	Triple Depth Cabinet w/Flat Top Cap 14' L x 3- 30" W Tables and 6- 12" W Benches	1585	\$16,762	\$506	\$1,011	\$2,568
RD-08-414-3012-HSLP	Quad Depth Cabinet w/Sloping Top Cap 14' L x 4- 30" W Tables and 8- 12" W Benches	2034	\$20,887	\$675	\$1,348	\$2,712
RD-08-414-3012-HFLT	Quad Depth Cabinet w/Flat Top Cap 14' L x 4- 30" W Tables and 8- 12" W Benches	2034	\$20,887	\$675	\$1,348	\$2,712

RD-08-14-2812-HSLP	Single Depth Cabinet w/Sloping Top Cap 14' L x 28" W Table and 2- 12" W Benches	615	\$6,054	\$169	\$337	\$678
RD-08-14-2812-HFLT	Single Depth Cabinet w/Flat Top Cap 14' L x 28" W Table and 2- 12" W Benches	615	\$6,054	\$169	\$337	\$678
RD-08-214-2812-HSLP	Double Depth Cabinet w/Sloping Top Cap 14' L x 2- 28" W Tables and 4- 12" W Benches	1110	\$10,961	\$337	\$675	\$1,355
RD-08-214-2812-HFLT	Double Depth Cabinet w/Flat Top Cap 14' L x 2- 28" W Tables and 4- 12" W Benches	1110	\$10,961	\$337	\$675	\$1,355
RD-08-314-2812-HSLP	Triple Depth Cabinet w/Sloping Top Cap 14' L x 3- 28" W Tables and 6- 12" W Benches	1585	\$16,762	\$506	\$1,011	\$2,568
RD-08-314-2812-HFLT	Triple Depth Cabinet w/Flat Top Cap 14' L x 3- 28" W Tables and 6- 12" W Benches	1585	\$16,762	\$506	\$1,011	\$2,568
RD-08-414-2812-HSLP	Quad Depth Cabinet w/Sloping Top Cap 14' L x 4- 28" W Tables and 8- 12" W Benches	2034	\$20,887	\$675	\$1,348	\$2,712
RD-08-414-2812-HFLT	Quad Depth Cabinet w/Flat Top Cap 14' L x 4- 28" W Tables and 8- 12" W Benches	2034	\$20,887	\$675	\$1,348	\$2,712

RD-08-14-2810-HSLP	Single Depth Cabinet w/Sloping Top Cap 14' L x 28" W Table and 2- 10" W Benches	615	\$6,054	\$169	\$337	\$678
RD-08-14-2810-HFLT	Single Depth Cabinet w/Flat Top Cap 14' L x 28" W Table and 2- 10" W Benches	615	\$6,054	\$169	\$337	\$678
RD-08-214-2810-HSLP	Double Depth Cabinet w/Sloping Top Cap 14' L x 2- 28" W Tables and 4- 10" W Benches	1110	\$10,961	\$337	\$675	\$1,355
RD-08-214-2810-HFLT	Double Depth Cabinet w/Flat Top Cap 14' L x 2- 28" W Tables and 4- 10" W Benches	1110	\$10,961	\$337	\$675	\$1,355
RD-08-314-2810-HSLP	Triple Depth Cabinet w/Sloping Top Cap 14' L x 3- 28" W Tables and 6- 10" W Benches	1585	\$16,762	\$506	\$1,011	\$2,568
RD-08-314-2810-HFLT	Triple Depth Cabinet w/Flat Top Cap 14' L x 3- 28" W Tables and 6- 10" W Benches	1585	\$16,762	\$506	\$1,011	\$2,568
RD-08-414-2810-HSLP	Quad Depth Cabinet w/Sloping Top Cap 14' L x 4- 28" W Tables and 8- 10" W Benches	2034	\$20,887	\$675	\$1,348	\$2,712
RD-08-414-2810-HFLT	Quad Depth Cabinet w/Flat Top Cap 14' L x 4- 28" W Tables and 8- 10" W Benches	2034	\$20,887	\$675	\$1,348	\$2,712

Additional "H/H" Sizes

Mitchell offers these Half-In/Half Out sizes also:

RD-08-13 - 13'-3" L at same price as above
RD-08-12 - 12' L at same price as above
RD-08-10 - 10' L ask Mitchell for price info.

Filler Top Caps & Panels for "H/H" Wall Units

Description	Wt.	Price	Description	Wt.	Price
Filler Cap - Sgle. Depth	20	\$235	24" O.A.W. Filler Panel	64	\$408
Filler Cap - Dbl. Depth	25	\$306	30" O.A.W. Filler Panel	68	\$515
Filler Cap - Trpl. Depth	30	\$387	36" O.A.W. Filler Panel	72	\$614
Filler Cap - Quad Depth	35	Contact Factory	Panel Receiver Channels	10	\$218

WALL MOUNTED TABLE AND BENCH SYSTEMS

14' Tables & Benches w/Set-In Wall Cabinet, Vinyl DuraEdge™ on 3/4" Resin Wood



Single-Depth
Set-In Wall

"S" Set-In Model	Description	Wt.	Price	Standard Upgrades		
				DuraEdge™ & Plywood	Lotz ArmorEdge™ & MDF	Lotz ArmorEdge™ & Plywood
RD-08-14-3012-S	Single Depth Cabinet w/Top & Side Flanges 14' L x 30" W Table and 2- 12" W Benches	615	\$5,872	\$169	\$337	\$678
RD-08-214-3012-S	Double Depth Cabinet w/Top & Side Flanges 14' L x 2- 30" W Tables and 4- 12" W Benches	1110	\$10,528	\$337	\$675	\$1,355
RD-08-314-3012-S	Triple Depth Cabinet w/Top & Side Flanges 14' L x 3- 30" W Tables and 6- 12" W Benches	1585	\$15,549	\$506	\$1,011	\$2,034
RD-08-414-3012-S	Quad Depth Cabinet w/Top & Side Flanges 14' L x 4- 30" W Tables and 8- 12" W Benches	2034	\$19,046	\$675	\$1,348	\$2,712
RD-08-14-2812-S	Single Depth Cabinet w/Top & Side Flanges 14' L x 28" W Table and 2- 12" W Benches	615	\$5,872	\$169	\$337	\$678
RD-08-214-2812-S	Double Depth Cabinet w/Top & Side Flanges 14' L x 2- 28" W Tables and 4- 12" W Benches	1110	\$10,528	\$337	\$675	\$1,355
RD-08-314-2812-S	Triple Depth Cabinet w/Top & Side Flanges 14' L x 3- 28" W Tables and 6- 12" W Benches	1585	\$15,549	\$506	\$1,011	\$2,034
RD-08-414-2812-S	Quad Depth Cabinet w/Top & Side Flanges 14' L x 4- 28" W Tables and 8- 12" W Benches	2034	\$19,046	\$675	\$1,348	\$2,712
RD-08-14-2810-S	Single Depth Cabinet w/Top & Side Flanges 14' L x 28" W Table and 2- 10" W Benches	615	\$5,872	\$169	\$337	\$678
RD-08-214-2810-S	Double Depth Cabinet w/Top & Side Flanges 14' L x 2- 28" W Tables and 4- 10" W Benches	1110	\$10,528	\$337	\$675	\$1,355
RD-08-314-2810-S	Triple Depth Cabinet w/Top & Side Flanges 14' L x 3- 28" W Tables and 6- 10" W Benches	1585	\$15,549	\$506	\$1,011	\$2,034
RD-08-414-2810-S	Quad Depth Cabinet w/Top & Side Flanges 14' L x 4- 28" W Tables and 8- 10" W Benches	2034	\$19,046	\$675	\$1,348	\$2,712

13'-3" Tables & Benches w/Set-In Wall Cabinet, Vinyl DuraEdge™ on 3/4" Resin Wood

"S" Set-In Model	Description	Wt.	Price	Standard Upgrades		
				DuraEdge™ & Plywood	Lotz ArmorEdge™ & MDF	Lotz ArmorEdge™ & Plywood
RD-08-13-3012-S	Single Depth Cabinet w/Top & Side Flanges 13'-3" L x 30" W Table and 2- 12" W Benches	615	\$5,872	\$169	\$337	\$678
RD-08-213-3012-S	Double Depth Cabinet w/Top & Side Flanges 13'-3" L x 2- 30" W Tables and 4- 12" W Benches	1110	\$10,528	\$337	\$675	\$1,355
RD-08-313-3012-S	Triple Depth Cabinet w/Top & Side Flanges 13'-3" L x 3- 30" W Tables and 6- 12" W Benches	1585	\$15,549	\$506	\$1,011	\$2,034
RD-08-413-3012-S	Quad Depth Cabinet w/Top & Side Flanges 13'-3" L x 4- 30" W Tables and 8- 12" W Benches	2034	\$19,046	\$675	\$1,348	\$2,712
RD-08-13-2812-S	Single Depth Cabinet w/Top & Side Flanges 13'-3" L x 28" W Table and 2- 12" W Benches	615	\$5,872	\$169	\$337	\$678
RD-08-213-2812-S	Double Depth Cabinet w/Top & Side Flanges 13'-3" L x 2- 28" W Tables and 4- 12" W Benches	1110	\$10,528	\$337	\$675	\$1,355
RD-08-313-2812-S	Triple Depth Cabinet w/Top & Side Flanges 13'-3" L x 3- 28" W Tables and 6- 12" W Benches	1585	\$15,549	\$506	\$1,011	\$2,034
RD-08-413-2812-S	Quad Depth Cabinet w/Top & Side Flanges 13'-3" L x 4- 28" W Tables and 8- 12" W Benches	2034	\$19,046	\$675	\$1,348	\$2,712
RD-08-13-2810-S	Single Depth Cabinet w/Top & Side Flanges 13'-3" L x 28" W Table and 2- 10" W Benches	615	\$5,872	\$169	\$337	\$678
RD-08-213-2810-S	Double Depth Cabinet w/Top & Side Flanges 13'-3" L x 2- 28" W Tables and 4- 10" W Benches	1110	\$10,528	\$337	\$675	\$1,355
RD-08-313-2810-S	Triple Depth Cabinet w/Top & Side Flanges 13'-3" L x 3- 28" W Tables and 6- 10" W Benches	1585	\$15,549	\$506	\$1,011	\$2,034
RD-08-413-2810-S	Quad Depth Cabinet w/Top & Side Flanges 13'-3" L x 4- 28" W Tables and 8- 10" W Benches	2034	\$19,046	\$675	\$1,348	\$2,712

Additional "S" Sizes

Mitchell offers these additional Set-In sizes:

RD-08-12 - 12' L - System & upgrade is priced as above.

RD-08-10 - 10' L - Ask Mitchell or Dealer for price information.

WALL MOUNTED TABLE AND BENCH SYSTEMS

14' L Table ONLY Against Wall Cabinet, Vinyl DuraEdge™ on 3/4" Resin Wood

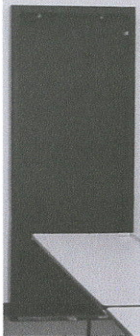

Single Flat Top Table ONLY Against Wall System

"A" Against Wall Table Only Model		Description	Wt.	Price	Standard Upgrades		
					DuraEdge™ & Plywood	Lotz ArmorEdge™ & MDF	Lotz ArmorEdge™ & Plywood
RD-08-14-30TO-ASLP	Single Depth Cabinet w/Sloping Top	14' L x 30" W Table	330	\$2,941	\$94	\$112	\$229
RD-08-14-30TO-AFLT	Single Depth Cabinet w/Flat Top	14' L x 30" W Table	330	\$2,941	\$94	\$112	\$229
RD-08-214-30TO-ASLP	Double Depth Cabinet w/Sloping Top	14' L x 30" W Table	555	\$5,101	\$187	\$225	\$457
RD-08-214-30TO-AFLT	Double Depth Cabinet w/Flat Top	14' L x 30" W Table	555	\$5,101	\$187	\$225	\$457
RD-08-314-30TO-ASLP	Triple Depth Cabinet w/Sloping Top	14' L x 30" W Table	770	\$7,446	\$281	\$337	\$685
RD-08-314-30TO-AFLT	Triple Depth Cabinet w/Flat Top	14' L x 30" W Table	770	\$7,446	\$281	\$337	\$685
RD-08-414-30TO-ASLP	Quad Depth Cabinet w/Sloping Top	14' L x 30" W Table	995	Ask Rep	\$375	\$449	\$914
RD-08-414-30TO-AFLT	Quad Depth Cabinet w/Flat Top	14' L x 30" W Table	995	Ask Rep	\$375	\$449	\$914
RD-08-14-28TO-ASLP	Single Depth Cabinet w/Sloping Top	14' L x 28" W Table	330	\$2,941	\$94	\$112	\$229
RD-08-14-28TO-AFLT	Single Depth Cabinet w/Flat Top	14' L x 28" W Table	330	\$2,941	\$94	\$112	\$229
RD-08-214-28TO-ASLP	Double Depth Cabinet w/Sloping Top	14' L x 28" W Table	555	\$5,101	\$187	\$225	\$457
RD-08-214-28TO-AFLT	Double Depth Cabinet w/Flat Top	14' L x 28" W Table	555	\$5,101	\$187	\$225	\$457
RD-08-314-28TO-ASLP	Triple Depth Cabinet w/Sloping Top	14' L x 28" W Table	770	\$7,446	\$281	\$337	\$685
RD-08-314-28TO-AFLT	Triple Depth Cabinet w/Flat Top	14' L x 28" W Table	770	\$7,446	\$281	\$337	\$685
RD-08-414-28TO-ASLP	Quad Depth Cabinet w/Sloping Top	14' L x 28" W Table	995	Ask Rep	\$375	\$449	\$914
RD-08-414-28TO-AFLT	Quad Depth Cabinet w/Flat Top	14' L x 28" W Table	995	Ask Rep	\$375	\$449	\$914

13'-3" L Table ONLY Against Wall Cabinet, Vinyl DuraEdge™ on 3/4" Resin Wood

RD-08-13-30TO-ASLP	Single Depth Cabinet w/Sloping Top	13'-3" L x 30" W Table	330	\$2,941	\$94	\$112	\$229
RD-08-13-30TO-AFLT	Single Depth Cabinet w/Flat Top	13'-3" L x 30" W Table	330	\$2,941	\$94	\$112	\$229
RD-08-213-30TO-ASLP	Dbl. Depth Cabinet w/Sloping Top	13' -3" L x 30" W Table	555	\$5,101	\$187	\$225	\$457
RD-08-213-30TO-AFLT	Dbl. Depth Cabinet w/Flat Top	13'-3" L x 30" W Table	555	\$5,101	\$187	\$225	\$457
RD-08-313-30TO-ASLP	Trpl. Depth Cabinet w/Sloping Top	13' -3" L x 30" W Table	770	\$7,446	\$281	\$337	\$685
RD-08-313-30TO-AFLT	Trpl. Depth Cabinet w/Flat Top	13'-3" L x 30" W Table	770	\$7,446	\$281	\$337	\$685
RD-08-413-30TO-ASLP	Quad Depth Cabinet w/Sloping Top	13' -3" L x 30" W Table	995	Ask Rep	\$375	\$449	\$914
RD-08-413-30TO-AFLT	Quad Depth Cabinet w/Flat Top	13'-3" L x 30" W Table	995	Ask Rep	\$375	\$449	\$914
RD-08-13-28TO-ASLP	Single Depth Cabinet w/Sloping Top	13'-3" L x 30" W Table	330	\$2,941	\$94	\$112	\$229
RD-08-13-28TO-AFLT	Single Depth Cabinet w/Flat Top	13'-3" L x 30" W Table	330	\$2,941	\$94	\$112	\$229
RD-08-213-28TO-ASLP	Dbl. Depth Cabinet w/Sloping Top	13' -3" L x 30" W Table	555	\$5,101	\$187	\$225	\$457
RD-08-213-28TO-AFLT	Dbl. Depth Cabinet w/Flat Top	13'-3" L x 30" W Table	555	\$5,101	\$187	\$225	\$457
RD-08-313-28TO-ASLP	Trpl. Depth Cabinet w/Sloping Top	13' -3" L x 30" W Table	770	\$7,446	\$281	\$337	\$685
RD-08-313-28TO-AFLT	Trpl. Depth Cabinet w/Flat Top	13'-3" L x 30" W Table	770	\$7,446	\$281	\$337	\$685
RD-08-413-28TO-ASLP	Quad Depth Cabinet w/Sloping Top	13' -3" L x 30" W Table	995	Ask Rep	\$375	\$449	\$914
RD-08-413-28TO-AFLT	Quad Depth Cabinet w/Flat Top	13'-3" L x 30" W Table	995	Ask Rep	\$375	\$449	\$914

See bottom of Page 3 for Filler Top Cap & Filler Panel Information.

Also available: RD-08-12 - 12' L at same prices as above.

WALL MOUNTED TABLE AND BENCH SYSTEMS

Replacement "A" Against Wall Cabinets for 14' L Table & Bench Units

"A" Against Wall Model	Description	Wt.	LIST PRICE
D-08-14-3012-ASLP	Single Depth w/Sloping Top Cap - 30" & 12" W Pockets	235	\$2,372
D-08-14-3012-AFLT	Single Depth w/Flat Top Cap - 30" & 12" W Pockets	235	\$2,372
D-08-214-3012-ASLP	Double Depth w/Sloping Top Cap - 30" & 12" W Pockets	340	\$3,359
D-08-214-3012-AFLT	Double Depth w/Flat Top Cap - 30" & 12" W Pockets	340	\$3,359
D-08-314-3012-ASLP	Triple Depth w/Sloping Top Cap - 30" & 12" W Pockets	445	\$4,770
D-08-314-3012-AFLT	Triple Depth w/Flat Top Cap - 30" & 12" W Pockets	445	\$4,770
D-08-414-3012-ASLP	Quad Depth w/Sloping Top Cap - 30" & 12" W Pockets	550	Contact Factory
D-08-414-3012-AFLT	Quad Depth w/Flat Top Cap - 30" & 12" W Pockets	550	Contact Factory
D-08-14-2812-ASLP	Single Depth w/Sloping Top Cap - 28" & 12" W Pockets	235	\$2,372
D-08-14-2812-AFLT	Single Depth w/Flat Top Cap - 28" & 12" W Pockets	235	\$2,372
D-08-214-2812-ASLP	Double Depth w/Sloping Top Cap - 28" & 12" W Pockets	340	\$3,359
D-08-214-2812-AFLT	Double Depth w/Flat Top Cap - 28" & 12" W Pockets	340	\$3,359
D-08-314-2812-ASLP	Triple Depth w/Sloping Top Cap - 28" & 12" W Pockets	445	\$4,770
D-08-314-2812-AFLT	Triple Depth w/Flat Top Cap - 28" & 12" W Pockets	445	\$4,770
D-08-414-2812-ASLP	Quad Depth w/Sloping Top Cap - 28" & 12" W Pockets	550	Contact Factory
D-08-414-2812-AFLT	Quad Depth w/Flat Top Cap - 28" & 12" W Pockets	550	Contact Factory
D-08-14-2810-ASLP	Single Depth w/Sloping Top Cap - 28" & 10" W Pockets	235	\$2,372
D-08-14-2810-AFLT	Single Depth w/Flat Top Cap - 28" & 10" W Pockets	235	\$2,372
D-08-214-2810-ASLP	Double Depth w/Sloping Top Cap - 28" & 10" W Pockets	340	\$3,359
D-08-214-2810-AFLT	Double Depth w/Flat Top Cap - 28" & 10" W Pockets	340	\$3,359
D-08-314-2810-ASLP	Triple Depth w/Sloping Top Cap - 28" & 10" W Pockets	445	\$4,770
D-08-314-2810-AFLT	Triple Depth w/Flat Top Cap - 28" & 10" W Pockets	445	\$4,770
D-08-414-2810-ASLP	Quad Depth w/Sloping Top Cap - 28" & 10" W Pockets	550	Contact Factory
D-08-414-2810-AFLT	Quad Depth w/Flat Top Cap - 28" & 10" W Pockets	550	Contact Factory

Replacement "H/H" Half-In/Half-Out Wall Cabinets for 14' L Table & Bench Units

"A" Against Wall Model	Description	Wt.	LIST PRICE
D-08-14-3012-HSLP	Single Depth w/Sloping Top Cap - 30" & 12" W Pockets	235	\$2,372
D-08-14-3012-HFLT	Single Depth w/Flat Top Cap - 30" & 12" W Pockets	235	\$2,372
D-08-214-3012-HSLP	Double Depth w/Sloping Top Cap - 30" & 12" W Pockets	340	\$3,359
D-08-214-3012-HFLT	Double Depth w/Flat Top Cap - 30" & 12" W Pockets	340	\$3,359
D-08-314-3012-HSLP	Triple Depth w/Sloping Top Cap - 30" & 12" W Pockets	445	\$4,770
D-08-314-3012-HFLT	Triple Depth w/Flat Top Cap - 30" & 12" W Pockets	445	\$4,770
D-08-414-3012-HSLP	Quad Depth w/Sloping Top Cap - 30" & 12" W Pockets	550	Contact Factory
D-08-414-3012-HFLT	Quad Depth w/Flat Top Cap - 30" & 12" W Pockets	550	Contact Factory
D-08-14-2812-HSLP	Single Depth w/Sloping Top Cap - 28" & 12" W Pockets	235	\$2,372
D-08-14-2812-HFLT	Single Depth w/Flat Top Cap - 28" & 12" W Pockets	235	\$2,372
D-08-214-2812-HSLP	Double Depth w/Sloping Top Cap - 28" & 12" W Pockets	340	\$3,359
D-08-214-2812-HFLT	Double Depth w/Flat Top Cap - 28" & 12" W Pockets	340	\$3,359
D-08-314-2812-HSLP	Triple Depth w/Sloping Top Cap - 28" & 12" W Pockets	445	\$4,770
D-08-314-2812-HFLT	Triple Depth w/Flat Top Cap - 28" & 12" W Pockets	445	\$4,770
D-08-414-2812-HSLP	Quad Depth w/Sloping Top Cap - 28" & 12" W Pockets	550	Contact Factory
D-08-414-2812-HFLT	Quad Depth w/Flat Top Cap - 28" & 12" W Pockets	550	Contact Factory
D-08-14-2810-HSLP	Single Depth w/Sloping Top Cap - 28" & 10" W Pockets	235	\$2,372
D-08-14-2810-HFLT	Single Depth w/Flat Top Cap - 28" & 10" W Pockets	235	\$2,372
D-08-214-2810-HSLP	Double Depth w/Sloping Top Cap - 28" & 10" W Pockets	340	\$3,359
D-08-214-2810-HFLT	Double Depth w/Flat Top Cap - 28" & 10" W Pockets	340	\$3,359
D-08-314-2810-HSLP	Triple Depth w/Sloping Top Cap - 28" & 10" W Pockets	445	\$4,770
D-08-314-2810-HFLT	Triple Depth w/Flat Top Cap - 28" & 10" W Pockets	445	\$4,770
D-08-414-2810-HSLP	Quad Depth w/Sloping Top Cap - 28" & 10" W Pockets	550	Contact Factory
D-08-414-2810-HFLT	Quad Depth w/Flat Top Cap - 28" & 10" W Pockets	550	Contact Factory

Replacement Cabinets also available, at the same price as above, for: RD-08-13 - 13'-3" Cabinet and RD-08-12 - 12' Cabinet. Contact the factory for information on the RD-08-10 - 10' Cabinet.

WALL MOUNTED TABLE AND BENCH SYSTEMS

Replacement "S" Set-In Wall Cabinets for 14' L Table & Bench Units

"S" Set-In Wall Model	Description	Wt.	LIST PRICE
D-08-14-3012-S	Single Depth - 30" & 12" W Pockets	235	\$2,022
D-08-214-3012-S	Double Depth - 30" & 12" W Pockets	340	\$2,803
D-08-314-3012-S	Triple Depth - 30" & 12" W Pockets	445	\$3,705
D-08-414-3012-S	Quad Depth - 30" & 12" W Pockets	550	Contact Factory
D-08-14-2812-S	Single Depth - 28" & 12" W Pockets	235	\$2,022
D-08-214-2812-S	Double Depth - 28" & 12" W Pockets	340	\$2,803
D-08-314-2812-S	Triple Depth - 28" & 12" W Pockets	445	\$3,705
D-08-414-2812-S	Quad Depth - 28" & 12" W Pockets	550	Contact Factory
D-08-14-2810-S	Single Depth - 28" & 10" W Pockets	235	\$2,022
D-08-214-2810-S	Double Depth - 28" & 10" W Pockets	340	\$2,803
D-08-314-2810-S	Triple Depth - 28" & 10" W Pockets	445	\$3,705
D-08-414-2810-S	Quad Depth - 28" & 10" W Pockets	550	Contact Factory

Replacement Table/Bench Cabinets also available, at the same price as above, for: RD-08-13 - 13'-3" Cabinet and RD-08-12 - 12' Cabinet. Contact the factory for information on the RD-08-10 - 10' Cabinet.

Replacement Table ONLY Wall Cabinets

"A" Against Wall Model	Description	Wt.	Price
D-08-14-30TO-A	Single Depth - 30" W Pockets	235	\$1,270
D-08-214-30TO-A	Double Depth - 30" W Pockets	340	\$1,746
D-08-314-30TO-A	Triple Depth - 30" & W Pockets	445	\$2,424
D-08-414-30TO-A	Quad Depth - 30" & W Pockets	550	Contact Factory

When ordering add "SLP" or "FLT" after the "A" for Sloping or Flat Top Cap.

Cabinets with 28" W table pocket and with pockets that hold a 13'-3", 12", & 10" L Table are also available. These options are priced the same as listed. As are Half-In/Half-Out Cabinets.

"S" Set-In Wall Model	Description	Wt.	Price
D-08-14-30TO-S	Single Depth - 30" W Pockets	235	\$1,048
D-08-214-30TO-S	Double Depth - 30" W Pockets	340	\$1,403
D-08-314-30TO-S	Triple Depth - 30" W Pockets	445	\$1,936
D-08-414-30TO-S	Quad Depth - 30" W Pockets	550	Contact Factory

Cabinets with 28" W table pocket and with pockets that hold a 13'-3", 12", & 10" L Table are also available. These options are priced the same as listed.

14' - 13'-3" - 12' Replacement Table & Bench Assemblies on 3/4" Resin Wood

Replacement Tables - (27" H Tables are also available)

Standard Upgrades - 1 Table

Model	Description	Wt.	Price	DuraEdge™ & Plywood	Lotz ArmorEdge™ & MDF	Lotz ArmorEdge™ & Plywood
DT-08-14-3029	Single Table 14' L x 30" W x 29" H	190	\$2,049	\$94	\$112	\$229
DT-08-14-2829	Single Table 14' L x 28" W x 29" H	190	\$2,049	\$94	\$112	\$229
DT-08-13-3029	Single Table 13'-3" L x 30" W x 29" H	190	\$2,049	\$94	\$112	\$229
DT-08-13-2829	Single Table 13'-3" L x 28" W x 29" H	190	\$2,049	\$94	\$112	\$229
DT-08-12-3029	Single Table 12' L x 30" W x 29" H	190	Ask Rep	\$87	\$128	\$236
DT-08-12-2829	Single Table 12' L x 28" W x 29" H	190	Ask Rep	\$87	\$139	\$247



Replacement Bench Sets - (shipped in pairs.)

Standard Upgrades - 2 Benches

Model	DESCRIPTION	Wt.	Price	DuraEdge™ & Plywood	Lotz ArmorEdge™ & MDF	Lotz ArmorEdge™ & Plywood
DB-08-14-1217	Two Benches 14' L x 12" W x 17" H	190	\$2,401	\$75	\$225	\$449
DB-08-14-1017	Two Benches 14' L x 10" W x 17" H	190	\$2,401	\$75	\$270	\$457
DB-08-13-1217	Two Benches 13'-3" L x 12" W x 17" H	190	\$2,401	\$75	\$225	\$449
DB-08-13-1017	Two Benches 13'-3" L x 10" W x 17" H	190	\$2,401	\$75	\$270	\$457
DB-08-12-1217	Two Benches 12' L x 12" W x 17" H	190	Ask Rep	\$67	\$180	\$442
DB-08-12-1017	Two Benches 12' L x 10" W x 17" H	190	Ask Rep	\$60	\$217	\$412

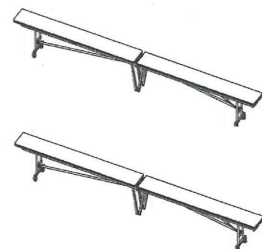

To order only 1 Bench Assembly order as a 1/2 unit (DB-08-14-1217-1/2) & reduce the List Price by half.

Mitchell

UPL0117-MF

THIS PRICE LIST
SUPERSEDES ALL OTHER
PREVIOUS SHEETS

MOBILE-FOLDING PRICE LIST

GP/NP/ST PorTables • ConverTable Bench • DUN & WO UniTables
Fold-N-Roll • Fold-O-Leg • 650 Series Seminar-Training Tables
Saturna Adjustable Leg Folding Tables • KD Pedestal Tables • Table Trucks



MITCHELL

FURNITURE SYSTEMS

1700 W. St. Paul Avenue Milwaukee, WI 53201
www.mitchell-tables.com sales@mitchell-tables.com
(Phone) 800-290-5960 or 414-342-3111 (Fax) 414-342-4239

TABLE OF CONTENTS

Mobile Tables w/Attached Seating

	Page
GP - Rectangular Folding Table w/Twin Bench or Individual Seating	3
NP - Rectangular Folding Table w/Bench or Individual Seating	3
ST - Elliptical Shaped Table w/Bench Seating	3

Mobile Folding Tables

CB ConverTable Bench - Three in One Bench/Table	4
DUN UniTables - Rectangular Mobile Folding Tables - Chrome Legs	4
WO UniTables - Rectangular Mobile Folding Tables	4
DC Conference Tables - Boat Shaped Tables	5
DS Seminar/Training Tables - Rectangular Mobile Folding Tables	5
Fold-N-Roll - Adjustable Height Shaped Mobile Folding Tables	5
Fold-N-Roll - Fixed Height Shaped Mobile Folding Tables	6
Product and Carton Information	5

Multi Purpose Folding & Pedestal Table

Fold-O-Leg Fixed Height Tables	7
650 Seminar/Training Fixed Height Tables	7
KD Fixed Height Pedestal Tables	7
Saturna Adjustable Height Tables	7
Table Trucks	Back

General Terms and Conditions

Additional Product Lines	2
Warranty	Back
Terms of Sale	Back

WE ALSO MANUFACTURE THESE PRODUCT LINES

Mitchell Wall Mounted Systems



Mitchell Wall Mounted Systems are available in a variety of cabinets styles including Against Wall, Half-In/Out and Set-In. Our wide selection offers lengths, heights and widths that best fit your needs and space requirements. The entire selection of Wall Mounted Systems is shown on our UPL0117WM Mitchell 2017 Wall Mounted Pricer. Please contact your Mitchell Dealer or Mitchell representative at 800/290-5960 for more information.

Mitchell Stage & Riser

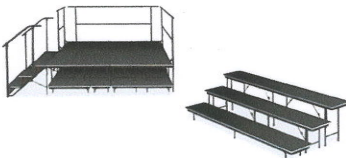

Mitchell Stages & Risers can be found on our UPL0117SR Mitchell Stage & Riser Pricer. A wide variety of Standing and Seated Tapered & Rectangular Risers for choral and band are available. In addition Mitchell offers a variety of stage platforms that are incredibly sturdy. Please contact your Mitchell Dealer or Mitchell representative at 800/290-5960 for more information.

Hamilton Medical Furniture



MOBILE-FOLDING TABLES WITH ATTACHED SEATING

GP PorTable w/Twin Bench & Individual Seats & Chrome Legs, Vinyl DuraEdge™ on 3/4" Particleboard



STANDARD UPGRADES

Model	Description	L	W	H	Seats	Wt.	List	DuraEdge™ & Plywood	Lotz ArmorEdge™ & MDF	Lotz ArmorEdge™ & Plywood
GP12-29	8 Bench Seats	12' 1"	30"	29"	16	369	\$2,993	\$139	\$375	\$652
GP12-27	8 Bench Seats	12' 1"	30"	27"	16	369	\$2,993	\$139	\$375	\$652
GP8/8-29	8 Single Seats	8'-1"	30"	29"	8	261	\$2,341	\$57	\$112	\$199
GP8/8-27	8 Single Seats	8'-1"	30"	27"	8	261	\$2,341	\$57	\$112	\$199
GP10/12-29	12 Single Seats	10'-1"	30"	29"	10	300	\$2,700	\$67	\$78	\$169
GP10/12-27	12 Single Seats	10'-1"	30"	27"	10	300	\$2,700	\$67	\$78	\$169
GP12/12-29	12 Single Seats	12'-1"	30"	29"	12	369	\$2,862	\$78	\$90	\$202
GP12/12-27	12 Single Seats	12'-1"	30"	27"	12	369	\$2,862	\$78	\$90	\$202
GP12/16-29	16 Single Seats	12'-1"	30"	29"	16	369	\$2,993	\$78	\$90	\$202
GP12/16-27	16 Single Seats	12'-1"	30"	27"	16	369	\$2,993	\$78	\$90	\$202

NP PorTable w/Full Bench & Individual Seats & Black Powder Coat Legs, Vinyl DuraEdge™ on 3/4" Particleboard

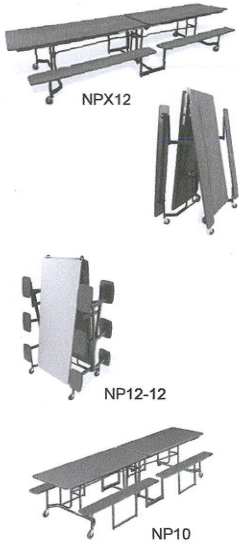

Model	Description	L	W	H	Seats	Wt.	List	DuraEdge™ & Plywood	Lotz ArmorEdge™ & MDF	Lotz ArmorEdge™ & Plywood
NPX8-29	Bench PorTable	8'-1"	30"	29"	8	245	\$1,872	\$94	\$307	\$520
NPX8-27	Bench PorTable	8'-1"	30"	27"	8	245	\$1,872	\$94	\$307	\$520
NPX10-29	Bench PorTable	10'-1"	30"	29"	12	290	\$2,014	\$112	\$251	\$536
NPX10-27	Bench PorTable	10'-1"	30"	27"	12	290	\$2,014	\$112	\$251	\$536
NPX12-29	Bench PorTable	12'-1"	30"	29"	16	310	\$2,071	\$139	\$264	\$570
NPX12-27	Bench PorTable	12'-1"	30"	27"	16	310	\$2,071	\$139	\$264	\$570
NP8-29	Bench PorTable	8' 1"	30"	29"	8	255	\$2,126	\$94	\$307	\$520
NP8-27	Bench PorTable	8' 1"	30"	27"	8	255	\$2,126	\$94	\$307	\$520
NP10-29	Bench PorTable	10'-1"	30"	29"	12	300	\$2,287	\$112	\$251	\$537
NP10-27	Bench PorTable	10'-1"	30"	27"	12	300	\$2,287	\$112	\$251	\$537
NP12-29	Bench PorTable	12'-1"	30"	29"	16	320	\$2,353	\$139	\$264	\$570
NP12-27	Bench PorTable	12'-1"	30"	27"	16	320	\$2,353	\$139	\$264	\$570
NP8/8-29	8 Single Seats	8' 1"	30"	29"	8	252	\$2,255	\$57	\$112	\$199
NP8/8-27	8 Single Seats	8' 1"	30"	27"	8	252	\$2,255	\$57	\$112	\$199
NP10/12-29	12 Single Seats	10'-1"	30"	29"	12	310	\$2,577	\$67	\$78	\$169
NP10/12-27	12 Single Seats	10'-1"	30"	27"	12	310	\$2,577	\$67	\$78	\$169
NP12/12-29	12 Single Seats	12'-1"	30"	29"	12	335	\$2,674	\$78	\$90	\$202
NP12/12-27	12 Single Seats	12'-1"	30"	27"	12	335	\$2,674	\$78	\$90	\$202
NP12/16-29	16 Single Seats	12'-1"	30"	29"	16	360	\$2,738	\$78	\$90	\$202
NP12/16-27	16 Single Seats	12'-1"	30"	27"	16	360	\$2,738	\$78	\$90	\$202

ST Shaped PorTable W/Bench & Individual Seats, Vinyl DuraEdge™ on 3/4" Particleboard



Model	Description	L	W	H	Seats	Wt.	List	DuraEdge™ & Plywood	Lotz ArmorEdge™ & MDF	Lotz ArmorEdge™ & Plywood
ST-4872-C429	Bench - Chrome	72"	48"	29"	8	255	\$2,260	\$108	\$330	\$551
ST-4872-C427	Bench - Chrome	72"	48"	27"	8	255	\$2,260	\$108	\$330	\$551
ST-4872-E429	Bench - Black	72"	48"	29"	8	255	\$2,168	\$108	\$330	\$551
ST-4872-E427	Bench - Black	72"	48"	27"	8	255	\$2,168	\$108	\$330	\$551
ST-4872-C429-8	8 Single - Chrome	72"	48"	29"	8	255	\$2,260	\$108	\$105	\$251
ST-4872-C427-8	8 Single - Chrome	72"	48"	27"	8	255	\$2,260	\$108	\$105	\$251
ST-4872-E429-8	8 Single - Black	72"	48"	29"	8	255	\$2,168	\$108	\$105	\$251
ST-4872-E427-8	8 Single - Black	72"	48"	27"	8	255	\$2,168	\$108	\$105	\$251

MOBILE-FOLDING TABLES

ConverTable 3in1 Bench/Table, Vinyl DuraEdge™ on 3/4" Particleboard



STANDARD UPGRADES

Model	Description	L	W	H	Seats	Wt.	List	DuraEdge™ & Plywood	Lotz ArmorEdge™ & MDF	Lotz ArmorEdge™ & Plywood
CB-1729-C96	Table/Bench, Chrome	96"	15"	29"	5	135	\$1008	\$50	\$77	\$174
CB-1727-C96	Table/Bench, Chrome	96"	15"	27"	5	135	\$1008	\$50	\$77	\$174
CB-1729-E96	Table/Bench, Black	96"	15"	29"	5	135	\$968	\$50	\$77	\$174
CB-1727-E96	Table/Bench, Black	96"	15"	27"	5	135	\$968	\$50	\$77	\$174
CB-1729-C84	Table/Bench, Chrome	84"	15"	29"	4	125	\$988	\$45	\$94	\$174
CB-1727-C84	Table/Bench, Chrome	84"	15"	27"	4	125	\$988	\$45	\$94	\$174
CB-1729-E84	Table/Bench, Black	84"	15"	29"	4	125	\$951	\$45	\$94	\$174
CB-1727-E84	Table/Bench, Black	84"	15"	27"	4	125	\$951	\$45	\$94	\$174
CB-1729-C72	Table/Bench, Chrome	72"	15"	29"	4	115	\$969	\$37	\$94	\$174
CB-1727-C72	Table/Bench, Chrome	72"	15"	27"	4	115	\$969	\$37	\$94	\$174
CB-1729-E72	Table/Bench, Black	72"	15"	29"	4	115	\$932	\$37	\$94	\$174
CB-1727-E72	Table/Bench, Black	72"	15"	27"	4	115	\$932	\$37	\$94	\$174
CB-1729-C60	Table/Bench, Chrome	60"	15"	29"	3	105	\$951	\$37	\$146	\$174
CB-1727-C60	Table/Bench, Chrome	60"	15"	27"	3	105	\$951	\$37	\$146	\$174
CB-1729-E60	Table/Bench, Black	60"	15"	29"	3	105	\$912	\$37	\$146	\$174
CB-1727-E60	Table/Bench, Black	60"	15"	27"	3	105	\$912	\$37	\$146	\$174

Fold-N-Roll UniTables, Vinyl DuraEdge™ on 3/4" Particleboard

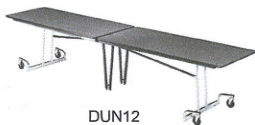

Model	Description	L	W	H	Seats	Wt.	List	DuraEdge™ & Plywood	Lotz ArmorEdge™ & MDF	Lotz ArmorEdge™ & Plywood
DUN8 29	Rectangle, Chrome	97"	30"	29"	8	156	\$1,235	\$57	\$112	\$199
DUN8 27	Rectangle, Chrome	97"	30"	27"	8	156	\$1,235	\$57	\$112	\$199
DUN10 29	Rectangle, Chrome	121"	30"	29"	12	174	\$1,301	\$67	\$78	\$169
DUN10 27	Rectangle, Chrome	121"	30"	27"	12	174	\$1,301	\$67	\$78	\$169
DUN12 29	Rectangle, Chrome	145"	30"	29"	16	194	\$1,370	\$78	\$90	\$202
DUN12 27	Rectangle, Chrome	145"	30"	27"	16	194	\$1,370	\$78	\$90	\$202



Model	Description	L	W	H	Seats	Wt.	List	DuraEdge™ & Plywood	Lotz ArmorEdge™ & MDF	Lotz ArmorEdge™ & Plywood
WO8 29	Rectangle, Black	97"	30"	29"	8	156	\$1,172	\$31	\$112	\$199
WO8 27	Rectangle, Black	97"	30"	27"	8	156	\$1,172	\$31	\$112	\$199
WO10 29	Rectangle, Black	121"	30"	29"	12	174	\$1,235	\$37	\$78	\$169
WO10 27	Rectangle, Black	121"	30"	27"	12	174	\$1,235	\$37	\$78	\$169
WO12 29	Rectangle, Black	145"	30"	29"	16	194	\$1,301	\$43	\$90	\$202
WO12 27	Rectangle, Black	145"	30"	27"	16	194	\$1,301	\$43	\$90	\$202

MOBILE-FOLDING TABLES

Conference Tables, Vinyl DuraEdge™ on 3/4" Particleboard

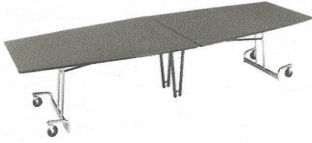

MODEL	DESCRIPTION	L	W	H	SEATS	WEIGHT	LIST PRICE
DC8 29	Boat Shaped Fold N Roll - Chrome Legs	97"	42"	29"	6	181 lbs.	\$1,708
DC10 29	Boat Shaped Fold N Roll - Chrome Legs	121"	42"	29"	8	196 lbs.	\$1,816
DC12 29	Boat Shaped Fold N Roll - Chrome Legs	145"	42"	29"	10	233 lbs.	\$1,933

Fold-N-Roll Seminar/Training Tables, Vinyl DuraEdge™ on 3/4" Particleboard



STANDARD UPGRADES

Model	Description	L	W	H	Seats	Wt.	List	DuraEdge™ & Plywood	Lotz ArmorEdge™ & MDF	Lotz ArmorEdge™ & Plywood
DS818-400 29	Rectangle, Chrome	97"	18"	29"	8-12	79	\$767	\$57	\$112	\$199
DS824-400 29	Rectangle, Chrome	97"	24"	29"	8-12	94	\$823	\$57	\$112	\$199
DS818-700	Rectangle, Adj. Chrome	97"	18"	22-	8-12	79	\$838	\$57	\$112	\$199
DS824-700	Rectangle, Adj. Chrome	97"	24"	22-	8-12	94	\$893	\$57	\$112	\$199

Adjustable Height Fold-N-Roll, Vinyl DuraEdge™ on 3/4" Particleboard



Model	Description	L	W	H	Seats	Wt.	List	DuraEdge™ & Plywood	Lotz ArmorEdge™ & MDF	Lotz ArmorEdge™ & Plywood
FR-48R-700	48" Round Chrome	48"	48"	22-29"	6-8	100	\$1,041	\$45	\$158	\$240
FR-486-700	48" Hexagon Chrome	48"	48"	22-29"	6	100	\$1,041	\$45	\$142	\$236
FR-484-700	48" Square Chrome	48"	48"	22-29"	8	112	\$1,041	\$45	\$101	\$232
FR-60R-700	60" Round Chrome	60"	60"	22-29"	8-10	138	\$1,204	\$67	\$101	\$199
FR-608-700	60" Octagon Chrome	60"	60"	22-29"	8	142	\$1,204	\$67	\$98	\$199

NOTE: Standard height adjustment is 22" - 29". "B" Height - 29" - 36" - add \$21 to List

MOBILE FOLDING TABLES - ADDITIONAL PRODUCT INFORMATION

- ⇒ **LAMINATE:** 100's of standard color and wood grain choices are available from the Wilsonart and Pionite. These are available at no additional charge. Optional laminate choices may also be considered at an upcharge.
- ⇒ **EDGE TREATMENT:** DuraEdge™ is an extended bullnose polyvinyl specifically designed by Mitchell engineers to provide the best bump resistance and moisture barrier and is fastened 6" O.C. around the entire table. Lotz ArmorEdge™ the original sprayed-on Polyurea edging, is designed as a moisture barrier that seals the table edge.
- ⇒ **ADA - WHEELCHAIR PRODUCTS:** Most Mitchell tables have 19" knee clearance, 30" width and are 29" high. Other ADA configurations are also available. Please contact your Mitchell Dealer or sales professional for assistance.

CARTON CHARGES

To help with a safe delivery PO's calling for 5 tables or less will be cartoned individually and will include special corrugated inserts designed to hold the table inside the carton. The cost for this special packaging is not included in our price, rather it is passed on to our customers without mark-up as follows:

PRODUCT	CHARGE PER TABLE
PorTables/Conference Tables	\$100
UniTables/Fold-N-Roll Tables	\$ 75
Seminar Tables	\$ 75

MOBILE-FOLDING TABLES

Fold-N-Roll Shaped Tables, Vinyl DuraEdge™ on 3/4" Particleboard

STANDARD UPGRADES



FR-48R-E429



FR-60R-C429



FR-72R-C429



FR-6066-C429



FR-6066-C429



FR-4872-C429

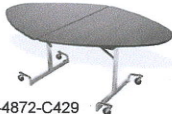

FR-484-E429



FR-6072-E429



Model	Description	L	W	H	Seats	WT	List	DuraEdge™ & Plywood	Lotz ArmorEdge™ & MDF	Lotz ArmorEdge™ & Plywood
FR-48R-C429	48" Round, Chrome	48"	48"	29"	6-8	95	\$909	\$45	\$158	\$240
FR-48R-C427	48" Round, Chrome	48"	48"	27"	6-8	95	\$909	\$45	\$158	\$240
FR-48R-E429	48" Round, Black	48"	48"	29"	6-8	95	\$872	\$45	\$158	\$240
FR-48R-E427	48" Round, Black	48"	48"	27"	6-8	95	\$872	\$45	\$158	\$240
FR-486-C429	48" Hexagon, Chrome	48"	48"	29"	6	94	\$909	\$45	\$142	\$236
FR-486-C427	48" Hexagon, Chrome	48"	48"	27"	6	94	\$909	\$45	\$142	\$236
FR-486-E429	48" Hexagon, Black	48"	48"	29"	6	94	\$872	\$45	\$142	\$236
FR-486-E427	48" Hexagon, Black	48"	48"	27"	6	94	\$872	\$45	\$142	\$236
FR-484-C429	48" Square, Chrome	48"	48"	29"	8	101	\$909	\$45	\$142	\$236
FR-484-C427	48" Square, Chrome	48"	48"	27"	8	101	\$909	\$45	\$142	\$236
FR-484-E429	48" Square, Black	48"	48"	29"	8	101	\$872	\$45	\$142	\$236
FR-484-E427	48" Square, Black	48"	48"	27"	8	101	\$872	\$45	\$142	\$236
FR-4872-C429	Elliptical, Chrome	72"	48"	29"	6-8	105	\$1,207	\$64	\$103	\$206
FR-4872-C427	Elliptical, Chrome	72"	48"	27"	6-8	105	\$1,207	\$64	\$103	\$206
FR-4872-E429	Elliptical, Black	72"	48"	29"	6-8	105	\$1,169	\$64	\$103	\$206
FR-4872-E427	Elliptical, Black	72"	48"	27"	6-8	105	\$1,169	\$64	\$103	\$206
FR-60R-C429	60" Round, Chrome	60"	60"	29"	8-10	126	\$1,073	\$67	\$101	\$199
FR-60R-C427	60" Round, Chrome	60"	60"	27"	8-10	126	\$1,073	\$67	\$101	\$199
FR-60R-E429	60" Round, Black	60"	60"	29"	8-10	126	\$1,035	\$67	\$101	\$199
FR-60R-E427	60" Round, Black	60"	60"	27"	8-10	126	\$1,035	\$67	\$101	\$199
FR-608-C429	60" Octagon, Chrome	60"	60"	29"	8	135	\$1,073	\$67	\$98	\$199
FR-608-C427	60" Octagon, Chrome	60"	60"	27"	8	135	\$1,073	\$67	\$98	\$199
FR-608-E429	60" Octagon, Black	60"	60"	29"	8	135	\$1,035	\$67	\$98	\$199
FR-608-E427	60" Octagon, Black	60"	60"	27"	8	135	\$1,035	\$67	\$98	\$199
FR-6066-C429	60" x 66" Oval, CH	60"	66"	29"	8-10	139	\$1,139	\$78	\$142	\$270
FR-6066-C427	60" x 66" Oval, CH	60"	66"	27"	8-10	139	\$1,139	\$78	\$142	\$270
FR-6066-E429	60" x 66" Oval, Black	60"	66"	29"	8-10	139	\$1,100	\$78	\$142	\$270
FR-6066-E427	60" x 66" Oval, Black	60"	66"	27"	8-10	139	\$1,100	\$78	\$142	\$270
FR-6072-C429	60" x 72" Oval, CH	60"	72"	29"	10-12	150	\$1,172	\$78	\$142	\$270
FR-6072-C427	60" x 72" Oval, CH	60"	72"	27"	10-12	150	\$1,172	\$78	\$142	\$270
FR-6072-E429	60" x 72" Oval, Black	60"	72"	29"	10-12	150	\$1,132	\$78	\$142	\$270
FR-6072-E427	60" x 72" Oval, Black	60"	72"	27"	10-12	150	\$1,132	\$78	\$142	\$270
FR-72R-C429	72" Round, Chrome	72"	72"	29"	10-12	174	\$1,289	\$98	\$48	\$158
FR-72R-C427	72" Round, Chrome	72"	72"	27"	10-12	174	\$1,289	\$98	\$48	\$158
FR-72R-E429	72" Round, Black	72"	72"	29"	10-12	174	\$1,249	\$98	\$48	\$158
FR-72R-E427	72" Round, Black	72"	72"	27"	10-12	174	\$1,249	\$98	\$48	\$158

MULTI-PURPOSE FOLDING & PEDESTAL TABLES

Fold-O-Leg Heavy Duty Folding Tables, Vinyl DuraEdge™ on 3/4" Particleboard



STANDARD UPGRADES

Model	Description	L	W	H	Ship Qty./Weight	List	DuraEdge™ & Plywood	Lotz ArmorEdge™ & MDF	Lotz ArmorEdge™ & Plywood
A-7	Rectangular Table	72"	24"	29"	2/131	\$570	\$39	\$45	N/A
A-5	Rectangular Table	96"	24"	29"	1/87	\$585	\$53	\$34	N/A
A-3	Rectangular Table	72"	30"	29"	1/82	\$551	\$39	\$45	N/A
A-1	Rectangular Table	96"	30"	29"	1/102	\$638	\$53	\$34	N/A
A-11	Rectangular Table	72"	36"	29"	1/97	\$600	\$66	\$30	N/A
A-9	Rectangular Table	96"	36"	29"	1/123	\$659	\$66	\$34	N/A
RA-121	Round Table	48"	48"	29"	1/81	\$662	\$45	\$158	N/A
RA-131	Round Table	60"	60"	29"	1/111	\$736	N/A	N/A	N/A

650 Series Seminar/Training Folding Tables, Vinyl DuraEdge™ on 3/4" Particleboard



Model	Description	L	W	H	Ship Qty./Weight	List	DuraEdge™ & Plywood	Lotz ArmorEdge™ & MDF	Lotz ArmorEdge™ & Plywood
650	Cantilever Black Legs	60"	18"	29"	2/110 lbs.	\$587	\$34	\$39	N/A
651	Cantilever Black Legs	72"	18"	29"	2/130 lbs.	\$628	\$39	\$45	N/A
652	Cantilever Black Legs	96"	18"	29"	2/152 lbs.	\$708	\$53	\$34	N/A
653	Cantilever Black Legs	60"	24"	29"	2/135 lbs.	\$667	\$34	\$39	N/A
654	Cantilever Black Legs	72"	24"	29"	2/155 lbs.	\$692	\$39	\$45	N/A
655	Cantilever Black Legs	96"	24"	29"	1/191 lbs.	\$701	\$53	\$34	N/A

KD Pedestal Table, Vinyl DuraEdge™ on 3/4" Particleboard



MODEL	DESCRIPTION	L	W	H	Ship Qty./Weight	List
36KD36	Square Table - Minimal Assembly Required	36"	36"	29"	2/129	\$676
KD42S	Square Table - Minimal Assembly Required	42"	42"	29"	2/150	\$687
KD48S	Square Table - Minimal Assembly Required	48"	48"	29"	2/187	\$829
KD36R	Round Table - Minimal Assembly Required	36"	36"	29"	2/110	\$610
KD42R	Round Table - Minimal Assembly Required	42"	42"	29"	2/126	\$716
KD48R	Round Table - Minimal Assembly Required	48"	48"	29"	2/165	\$810

Saturna Adjustable Height Folding Tables w/Chrome Leg, Vinyl DuraEdge™ on 3/4" Particleboard



Model	Description	L	W	H	Ship Qty./Weight	List	DuraEdge™ & Plywood	Lotz ArmorEdge™ & MDF	Lotz ArmorEdge™ & Plywood
732-A	Rectangular	60"	18"	22"- 29"	2/110 lbs.	\$585	\$34	\$39	\$84
731-A	Rectangular	72"	18"	22"- 29"	2/130 lbs.	\$627	\$39	\$45	\$101
729-A	Rectangular	96"	18"	22"- 29"	2/152 lbs.	\$708	\$53	\$34	\$98
708-A	Rectangular	60"	24"	22"- 29"	2/135 lbs.	\$664	\$34	\$39	\$84
707-A	Rectangular	72"	24"	22"- 29"	2/155 lbs.	\$692	\$39	\$45	\$101
705-A	Rectangular	96"	24"	22"- 29"	1/91 lbs.	\$749	\$53	\$34	\$98
741-A	Rectangular	60"	30"	22"- 29"	2/159 lbs.	\$692	\$34	\$39	\$84
703-A	Rectangular	72"	30"	22"- 29"	1/91 lbs.	\$701	\$39	\$45	\$101
701-A	Rectangular	96"	30"	22"- 29"	1/110 lbs.	\$801	\$53	\$34	\$98
714-A	Rectangular	60"	36"	22"- 29"	1/90 lbs.	\$879	\$66	\$30	\$87
711-A	Rectangular	72"	36"	22"- 29"	1/103 lbs.	\$764	\$66	\$30	\$67
709-A	Rectangular	96"	36"	22"- 29"	1/127 lbs.	\$834	\$53	\$34	\$101
R7-121-A	Round	48"	48"	22"- 29"	1/105 lbs.	\$829	\$45	\$158	\$119
R7-131-A	Round	60"	60"	22"- 29"	1/121 lbs.	\$906	\$67	\$101	N/A
T6-703-A	Trapezoid	72"	48"	22"- 29"	1/74 lbs.	\$770	\$45	\$71	\$118

Standard "A" Table - 22"-29" Ht. Adjusting. Optional "B" Table - 29"-36" Ht. Adjusting - add \$21 to list.

MULTI-PURPOSE TABLE TRUCKS

Table Trucks



T-49

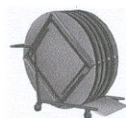

T-46

MODEL	TABLE SIZE	WEIGHT	LIST PRICE
T-47	Flat load 18" x 60"/72"	48 lbs.	\$619
T-49	Flat load 18" x 96"	51 lbs.	\$645
T-34	Flat load all W to 72" L	55 lbs.	\$687

MODEL	TABLE SIZE	WEIGHT	LIST PRICE
T-45	Flat load 24" x 96"	60 lbs.	\$717
T-38	Flat load all W to 96" L	65 lbs.	\$773
T-46	Edge load 48" Round	55 lbs.	\$773
T-36	Edge load 60" Round	60 lbs.	\$832

GENERAL TERMS AND CONDITIONS

TERMS OF SALE - 30 days net to trade of established credit. No anticipation, no dating, 1½% per month service charge on overdue accounts. Where no credit is established, arrangements must be made regarding terms. All prices are F.O.B. Milwaukee, Wisconsin, without freight allowances.

ORDERS - All orders and contracts are subject to acceptance at Milwaukee, Wisconsin, and are contingent upon fires, strikes, accidents or other causes beyond our control. Shipments are made at purchaser's risk. All prices are quoted for immediate acceptance and are subject to change without notice. Prices prevailing at time of shipment must apply. Clerical errors are subject to correction.

PHONE ORDERS - "Confirmation" must follow immediately. Duplicate orders not marked or identified as "confirmation" are the responsibility of the customer.

ACKNOWLEDGEMENTS - Every order is acknowledged. Orders are manufactured and invoiced based upon the information in the acknowledgement. If there is any discrepancy, the dealer must notify Mitchell Furniture Systems within 5 working days. Orders are accepted by Mitchell Furniture Systems per terms herein and on the acknowledgement. Mitchell Furniture Systems rejects any terms and conditions contained in any customer purchase orders or other business forms which are different from the terms stated herein and on the acknowledgement.

SHIPMENT DAMAGE CLAIMS - All shipments should be carefully inspected by the consignee before acceptance and the delivering carrier should be requested to record any damage or shortage on the delivery receipt before the consignee signs it. If further damage is found after delivery, immediate inspection by the delivering carrier should be requested. Notification of concealed damages must be made to the delivering carrier within 15 days after delivery of merchandise. Carrier liability ceases after 15 days.

CAUTION: After obtaining a clear receipt for the shipment, the delivering carrier is no longer responsible for damage or shortages.

RETURNS - Merchandise returned will not be accepted without prior written consent of Mitchell Furniture Systems. After approval, returned merchandise must be shipped pre-paid and subject to 50% handling charge unless it is Mitchell's responsibility.

WARRANTY - Mitchell Furniture Systems warrants products purchased hereunder to be free of defects in materials and workmanship for a period of fifteen (15) years from the date of shipment. This warranty shall not apply in the event products are damaged as a result of misuse, abuse, neglect, accident, improper application, modification or repair by persons not authorized by Mitchell Furniture Systems, where products are damaged during shipment, or where date stamps on the products have been defaced, modified or removed. **UNLESS CONSIDERED UNENFORCEABLE OR UNLAWFUL UNDER APPLICABLE LAW.**

- a. ALL IMPLIED WARRANTIES, INCLUDING BUT NOT LIMITED TO WARRANTIES OF MERCHANTABILITY AND FITNESS FOR A PARTICULAR PURPOSE ARE HEREBY EXCLUDED.
- b. PURCHASER'S REMEDY, IF ANY, FOR ANY DEFECTIVE PRODUCTS SHALL BE LIMITED TO A REFUND, REPLACEMENT OR ADJUSTMENT BY MITCHELL FURNITURE SYSTEMS OF THE PRODUCTS AT MITCHELL FURNITURE SYSTEMS OPTION, AND SHALL IN NO EVENT INCLUDE DAMAGES OF ANY KIND, WHETHER INCIDENTAL, CONSEQUENTIAL OR OTHERWISE.

We reserve the right to make any changes in price, design and material specifications without notice.



UPL0117-SR

THIS PRICE SHEET
SUPERSEDES ALL OTHER
PREVIOUS SHEETS

STAGE & RISER PRICE LIST

Tapered & Rectangular Choral Risers - Seated Band Risers - Trucks
4' x 8' Stage Platforms - Stage Stairs & ADA Ramps - Carpet & Skirting



1700 W. St. Paul Avenue Milwaukee, WI 53201
www.mitchell-tables.com sales@mitchell-tables.com
(Phone) 800-290-5960 or 414-342-3111 (Fax) 414-342-4239



2017 Mitchell Furniture Systems Pricer Portable Stage and Risers

18"-W STANDING TAPERED CHORAL RISERS

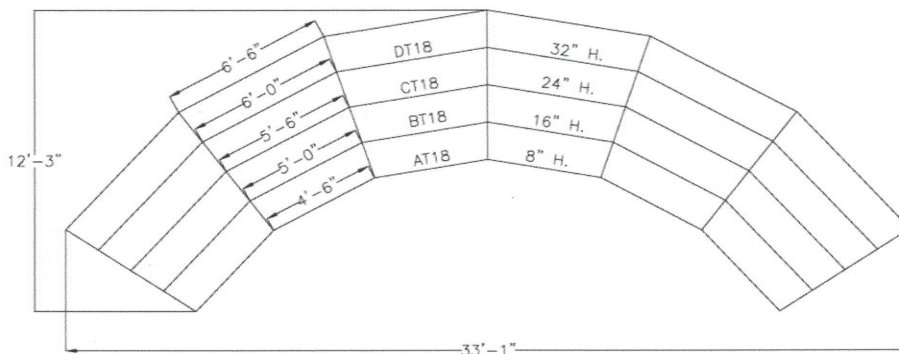

<u>Category</u>	<u>Model</u>	<u>Singers</u> (Includes Floor)	<u>Description</u>	<u>Length</u>	<u>Width</u>	<u>Height</u>	<u>Weight</u>	<u>List Price</u>
Individual Tapered Risers	AT18	1st Tier Tapered Riser	54" x 60"	18"	8"	40 lbs.	\$	456
	BT18	2nd Tier Tapered Riser	60" x 66"	18"	16"	50 lbs.	\$	511
	CT18	3rd Tier Tapered Riser	66" x 72"	18"	24"	60 lbs.	\$	666
	DT18	4th Tier Tapered Riser	72" x 78"	18"	32"	68 lbs.	\$	685

3 Tier Sets of Tapered Risers	TR314	14	3 Tier Section Consisting of 1 Each: AT18, BT18, CT18	6' 0"	4'6"	8" to 24"	150 lbs.	\$	1,634
	TR328	28	6 Tier Section Consisting of 2 Each: AT18, BT18, CT18	11' 9"	5'4"	8" to 24"	300 lbs.	\$	3,267
	TR343	43	9 Tier Section Consisting of 3 Each: AT18, BT18, CT18	17'3"	6'0"	8" to 24"	450 lbs.	\$	4,902
	TR357	57	12 Tier Section Consisting of 4 Each: AT18, BT18, CT18	22'4"	7'5"	8" to 24"	600 lbs.	\$	6,536
	TR371	71	15 Tier Section Consisting of 5 Each: AT18, BT18, CT18	26'9"	8'8"	8" to 24"	750 lbs.	\$	8,171
	TR386	86	18 Tier Section Consisting of 6 Each: AT18, BT18, CT18	30'6"	10'7"	8" to 24"	900 lbs.	\$	9,806
	TR3100	100	21 Tier Section Consisting of 7 Each: AT18, BT18, CT18	33'6"	12'4"	8" to 24"	1050 lbs.	\$	11,439

4 Tier Sets of Tapered Risers	TR419	19	4 Tier Section Consisting of 1 Ea: AT18, BT18, CT18, DT18	6'6"	6'0"	8" to 32"	218 lbs.	\$	2,321
	TR438	38	8 Tier Section Consisting of 2 Ea: AT18, BT18, CT18, DT18	12'10"	6'10"	8" to 32"	431 lbs.	\$	4,640
	TR458	58	12 Tier Section Consisting of 3 Ea: AT18, BT18, CT18, DT18	18'9"	7'5"	8" to 32"	649 lbs.	\$	6,962
	TR477	77	16 Tier Section Consisting of 4 Ea: AT18, BT18, CT18, DT18	24'3"	9'0"	8" to 32"	862 lbs.	\$	9,283
	TR496	96	20 Tier Section Consisting of 5 Ea: AT18, BT18, CT18, DT18	29'1"	10'2"	8" to 32"	1080 lbs.	\$	11,602
	TR4116	116	24 Tier Section Consisting of 6 Ea: AT18, BT18, CT18, DT18	33'0"	12'2"	8" to 32"	1293 lbs.	\$	13,924
	TR4135	135	28 Tier Section Consisting of 7 Ea: AT18, BT18, CT18, DT18	36'3"	13'11"	8" to 32"	1511 lbs.	\$	16,244



2017 Mitchell Furniture Systems Pricer Portable Stage and Risers

36"-W STANDING TAPERED CHORAL RISERS

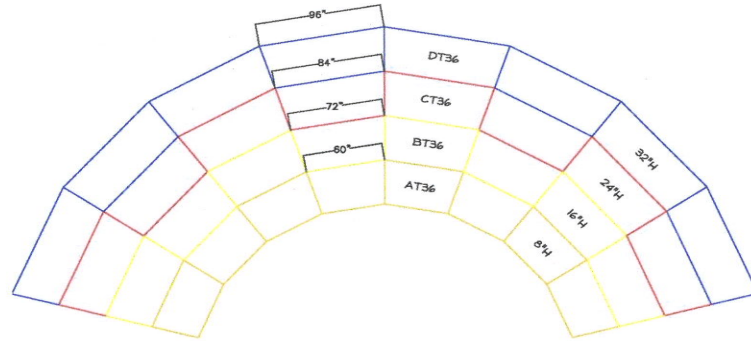

Category	Model	Singers (Includes Floor)	Description	Length	Width	Height	Weight	List Price
Individual Tapered Risers	AT36		1st Tier Tapered Riser	48" x 60"	36"	8"	65 lbs.	\$ 687
	BT36		2nd Tier Tapered Riser	60" x 72"	36"	16"	90 lbs.	\$ 848
	CT36		3rd Tier Tapered Riser	72" x 84"	36"	24"	110 lbs.	\$ 1,027
	DT36		4th Tier Tapered Riser	84" x 96"	36"	32"	120 lbs.	\$ 1,173



3 Tier Sets of Tapered Risers	TR313	13	3 Tier Section Consisting of 1 Each: AT36, BT36, CT36	7' 0"	9'0"	8" to 24"	265 lbs.	\$ 2,562
	TR326	26	6 Tier Section Consisting of 2 Each: AT36, BT36, CT36	13' 10"	9'10"	8" to 24"	530 lbs.	\$ 5,124
	TR339	39	9 Tier Section Consisting of 3 Each: AT36, BT36, CT36	20'4"	10'4"	8" to 24"	795 lbs.	\$ 7,686
	TR352	52	12 Tier Section Consisting of 4 Each: AT36, BT36, CT36	26'2"	11'9"	8" to 24"	1060 lbs	\$ 10,250
	TR365	65	15 Tier Section Consisting of 5 Each: AT36, BT36, CT36	31'3"	12'9"	8" to 24"	1325 lbs	\$ 12,810
	TR378	78	18 Tier Section Consisting of 6 Each: AT36, BT36, CT36	35'8"	14'8"	8" to 24"	1590 lbs	\$ 15,373
	TR391	91	21 Tier Section Consisting of 7 Each: AT36, BT36, CT36	38'10"	16'2"	8" to 24"	1855 LBS.	\$ 17,934

4 Tier Sets of Tapered Risers	TR418	18	4 Tier Section Consisting of 1 Ea: AT36, BT36, CT36, DT36	8'0"	12'0"	8" to 32"	385 lbs.	\$ 3,736
	TR436	36	8 Tier Section Consisting of 2 Ea: AT36, BT36, CT36, DT36	15'9"	13'0"	8" to 32"	650 lbs	\$ 7,470
	TR454	54	12 Tier Section Consisting of 3 Ea: AT36, BT36, CT36, DT36	23'2"	13'4"	8" to 32"	915 lbs	\$ 11,206
	TR472	72	16 Tier Section Consisting of 4 Ea: AT36, BT36, CT36, DT36	30'0"	14'9"	8" to 32"	1180 lbs	\$ 14,941
	TR490	90	20 Tier Section Consisting of 5 Ea: AT36, BT36, CT36, DT36	35'10"	15'10"	8" to 32"	1445 lbs	\$ 18,675
	TR4108	108	24 Tier Section Consisting of 6 Ea: AT36, BT36, CT36, DT36	40'9"	17'8"	8" to 32"	1710 lbs	\$ 22,410
	TR4126	126	28 Tier Section Consisting of 7 Ea: AT36, BT36, CT36, DT36	44'6"	19'2"	8" to 32"	2095 lbs	\$ 26,144



2017 Mitchell Furniture Systems Pricer Portable Stage and Risers

15" & 33"-W RECTANGULAR CHORAL & BAND RISERS

Category	Model	Description	Length	Width	Height	Weight	List Price
INDIVIDUAL 15" RECTANGULAR STANDING RISERS							
	A15	1st Tier Rectangular Riser	96"	15"	8"	60 lbs.	\$ 593
	B15	2nd Tier Rectangular Riser	96"	15"	16"	65 lbs.	\$ 637
	C15	3rd Tier Rectangular Riser	96"	15"	24"	70 lbs.	\$ 673
	D15	4th Tier Rectangular Riser	96"	15"	32"	75 lbs.	\$ 690
INDIVIDUAL 33" RECTANGULAR SEATED RISERS							
	A33	1st Tier Rectangular Riser	96"	33"	8"	100 lbs.	\$ 835
	B33	2nd Tier Rectangular Riser	96"	33"	16"	105 lbs.	\$ 980
	C33	3rd Tier Rectangular Riser	96"	33"	24"	115 lbs.	\$ 1,082
	D33	4th Tier Rectangular Riser	96"	33"	32"	125 lbs.	\$ 1,180
INDIVIDUAL 15" & 33" RECTANGULAR SEATED RISERS							
		<p>15" and 33" Rectangular Risers may be combined to form a sturdy seated 48" x 96" band riser. 15" risers have a swinging clamp at one end and 2 strap clamps on the 96" side. 33" risers have a swinging clamp at each end and 2 swinging clamps on one 96" side and on the other 96" side there are strap clamps. All steel components are powder coated jet black with the exception of the edge treatment which is galvanized steel and is zinc coated. Legs are 14 gauge and "U" channel aprons are 16 gauge. Surfaces are rugged 3/4" thick plywood with a black non-skid Panelam™ finish.</p>					

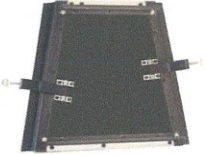

RISER ACCESSORIES

Category	Model	Description	Length	Width	Height	Weight	List Price
TAPERED RISERS							
 <p style="font-size: small;">Tapered Inserts convert rectangular risers into sets of tapered risers.</p>	Spc.	Small Tapered Insert		15"	8"	7 lbs.	\$ 121
	Spc.	Small Tapered Insert		15"	16"	10 lbs.	\$ 135
	Spc.	Small Tapered Insert		15"	24"	15 lbs.	\$ 169
	Spc.	Small Tapered Insert		15"	32"	20 lbs.	\$ 180
	Spc.	Large Tapered Insert		33"	8"	10 lbs.	\$ 164
	Spc.	Large Tapered Insert		33"	16"	15 lbs.	\$ 200
	Spc.	Large Tapered Insert		33"	24"	20 lbs.	\$ 256
	Spc.	Large Tapered Insert		33"	32"	30 lbs.	\$ 524
Note: Additional sizes available consult with Mitchell Customer Service							

CHAIR STOPS

 <p style="font-size: small;">Chair stops help to keep chairs from slipping off the top row of seated riser. Angular steel clamps on, jet black powder coat finish.</p>	CS48	48" Long Chair Stop	48"	1-1/4"	1-1/4"	3 lbs.	\$ 52
	CS60	60" Long Chair Stop	60"	1-1/4"	1-1/4"	3-1/2 lbs.	\$ 63
	CS72	72" Long Chair Stop	72"	1-1/4"	1-1/4"	4-1/2 lbs.	\$ 67
	CS84	84" Long Chair Stop	84"	1-1/4"	1-1/4"	5 lbs.	\$ 74
	CS96	96" Long Chair Stop	96"	1-1/4"	1-1/4"	5-1/2 lbs.	\$ 76

CARPETING & BOX PLEATED SKIRTING

 <p style="font-size: small;">Skirts 1" shorter than stage height. Handling Fee w/ quote.</p> 	#500 Continuous Box Skirting	0 - 18"	Per Foot Price:	Contact Factory
	#500 Continuous Box Skirting	18" - 30"	Per Foot Price:	
	#500 Continuous Box Skirting	30" - 39"	Per Foot Price:	
	#500 Continuous Box Skirting	39" - 60"	Per Foot Price:	
	Hook & Loop Velcro		Per Foot Price:	
	Carpet - Stone Gray Color		Per Foot Price:	



2017 Mitchell Furniture Systems Pricer Portable Stage and Risers

STAGE PLATFORMS

Category	Model	Description	Length	Width	Height	Weight	List Price
4'x 8' PLATFORMS 48"  96"	A48	96" L x 8" H Portable Stage	96"	48"	8"	145 lbs.	\$ 1,268
	B48	96" L x 16" H Portable Stage	96"	48"	16"	155 lbs.	\$ 1,354
	C48	96" L x 24" H Portable Stage	96"	48"	24"	170 lbs.	\$ 1,469
	D48	96" L x 32" H Portable Stage	96"	48"	32"	180 lbs.	\$ 1,627
	E48	96" L x 40" H Portable Stage	96"	48"	40"	200 lbs.	\$ 1,676
	X48	96" L x 42" H Portable Stage	96"	48"	42"	200 lbs.	\$ 1,695
	F48	96" L x 48" H Portable Stage	96"	48"	48"	220 lbs.	\$ 1,772

4'x 4' PLATFORMS 48"  48"	Sp. 488	48" L x 8" H Portable Stage	48"	48"	8"	85 lbs.	\$ 818
	Sp. 4816	48" L x 16" H Portable Stage	48"	48"	16"	95 lbs.	\$ 885
	Sp. 4824	48" L x 24" H Portable Stage	48"	48"	24"	100 lbs.	\$ 1,019
	Sp. 4832	48" L x 32" H Portable Stage	48"	48"	32"	110 lbs.	\$ 1,062
	Sp. 4840	48" L x 40" H Portable Stage	48"	48"	40"	120 lbs.	\$ 1,152
	Sp. 4842	48" L x 42" H Portable Stage	48"	48"	42"	130 lbs.	\$ 1,181
	Sp. 4848	48" L x 48" H Portable Stage	48"	48"	48"	135 lbs.	\$ 1,211

3' x 8' Platforms 36"  96"	Sp. 368	96" L x 8" H Portable Stage	96"	36"	8"	105 lbs.	\$ 1,124
	SP. 3616	96" L x 16" H Portable Stage	96"	36"	16"	120 lbs.	\$ 1,279
	SP. 3624	96" L x 24" H Portable Stage	96"	36"	24"	130 lbs.	\$ 1,354
	SP. 3632	96" L x 32" H Portable Stage	96"	36"	32"	140 lbs.	\$ 1,602
	SP. 3640	96" L x 40" H Portable Stage	96"	36"	40"	160 lbs.	\$ 1,703
	SP. 3642	96" L x 42" H Portable Stage	96"	36"	42"	165 lbs.	\$ 1,728
	SP. 3648	96" L x 48" H Portable Stage	96"	36"	48"	175 lbs.	\$ 1,797

SPECIAL SEATED BAND, ORCHESTRA & CHORAL RISER PLATFORM PLANS - CONT'D

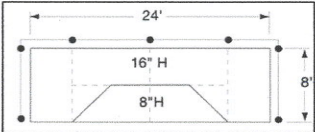
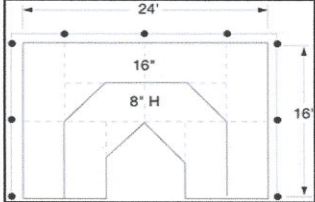
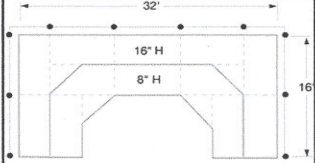
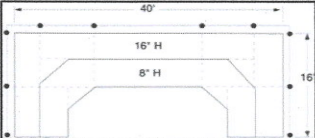
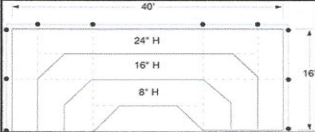
Diagram	No. Musicians		Plan # & Description	Space Required		Height	Weight	List Price
	Stand	Area		Length	Depth			
	22	22	No. B01 - Qty. of platforms in this plan 2- A48; 4- B48; 2- T48 Tri-Corners Add Guard Rails: \$1197 List/200 lbs.	24'	8'	8" to 16"	1012 lbs.	\$ 8,903
	39	45	No. B02 - Qty of Platforms in this plan 4- A48; 6- B48; 4- T48 Tri-Corners Add Guard Rails: \$1744 List/255 lbs.	24'	16'	8" to 16"	1684 lbs.	\$ 15,098
	47	60	No. B03 - Qty of Platforms in this plan 5- A48; 7- B48; 4- T48 Tri-Corners Add Guard Rails: \$1744List/300 lbs.	32'	16'	8" to 16"	1962 lbs.	\$ 17,718
	54	75	No. B04 - Qty of Platforms in this Plan 6- A48; 8- B48; 4- T48 Tri-Corners Add Guard Rails: \$2039 List/350 lbs.	40'	16'	8" to 16"	2244 lbs.	\$ 20,339
	69	75	No. B05 - Qty of Platforms in this Plan 4- A48; 6- B48; 8- C48; 6- T48 Add Guard Rails: \$2039 List/350 lbs.	40'	16'	8" to 24"	3097 lbs.	\$ 27,794



2017 Mitchell Furniture Systems Pricer Portable Stage and Risers

SEATED PLATFORMS

SPECIAL SEATED BAND, ORCHESTRA & CHORAL RISER PLATFORM PLANS - CONT'D

Diagram	No. Musicians		Plan # & Description	Space Required		Height	Weight	List Price
	Stand	Area		Length	Depth			
	69	75	No. B06 - Qty. of platforms in this plan 4- A48; 6- B48; 8- C48; 6- T48 Add Guard Rails: \$2009 List/350 lbs.	32'	20'	8" to 24"	3097 lbs.	\$ 27,794
	80	94	No. B07 - Qty of Platforms in this plan 5- A48; 7- B48; 9- C48; 6- T48 Add Guard Rails: \$2110 List/360 lbs.	40'	20'	8" to 24"	3582 lbs.	\$ 31,883
	92	112	No. B08 - Qty of Platforms in this plan 6- A48; 8- B48; 10- C48; 6- T48 Add Guard Rails: \$2408 List/410 lbs.	40'	24'	8" to 24"	4011 lbs.	\$ 35,971
	80	90	No. B09 - Qty of Platforms in this Plan 5- A48; 7- B48; 9- C48; 4- T48 Add Guard Rails: \$2113 List/380 lbs.	48'	16'	8" to 24"	3582 lbs.	\$ 30,930
	69	75	No B010 - Qty of Platforms in this Plan 7- A48; 9- B48; 11- C48; 6- T48 Add Guard Rails: \$2482 List/430 lbs.	48'	24'	8" to 24"	4250 lbs.	\$ 40,060
	64	80	80 Seated Singer Riser Set Qty: 4-SPC368; 4-SPC3616; 4-SPC3624; 4-SPC3632 Add Guard Rails: \$1743 List/255 lbs.	32'	12'	8" to 32"	1980 lbs.	\$ 21,434
	77	95	95 Seated Singer Riser Set Qty: 3-SPC368; 3-SPC3616; 3-SPC3624; 4- AT36; 4- BT36; 4- CT36 Add Guard Rails: Quote from Factory	30'6"	17'3"	8" to 24"	2125 lbs.	\$ 21,521
	106	135	135 Seated Singer Riser Set Qty: 5-SPC368; 5-SPC3616; 5-SPC3624; 4- AT36; 4- BT36; 4- CT36 Add Guard Rails: \$2039 List/350 lbs.	40'8"	17'3"	8" to 24"	2835 lbs.	\$ 28,190



2017 Mitchell Furniture Systems Pricer Portable Stage and Risers

STAGE ACCESSORIES

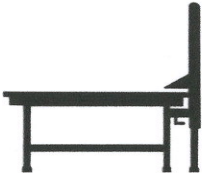
Category	Model	Description	Length	Width	Height	Weight	List Price
GUARD RAILS  All guard rails will have two 1-5/16" O.D. steel uprights w/clamp per platform section. Steel extension posts are required with each railing set. These reach the floor and provide even greater stability.	A-3	3' Straight Guard Rail	36"	1-5/16"	N/A	30 lbs.	\$ 386
	A-4	4' Straight Guard Rail	48"	1-5/16"	N/A	38 lbs.	\$ 397
	A-5	5'6" Straight Guard Rail	66"	1-5/16"	N/A	45 lbs.	\$ 408
	A-6	6' Straight Guard Rail	72"	1-5/16"	N/A	50 lbs.	\$ 426
	A-7	7' Straight Guard Rail	84"	1-5/16"	N/A	50 lbs.	\$ 451
	A-8	8' Straight Guard Rail	96"	1-5/16"	N/A	55 lbs.	\$ 468
	A-9	9' Straight Guard Rail	108"	1-5/16"	N/A	60 lbs.	\$ 500
	B-3	3' Angular Guard Rail	36"	1-5/16"	N/A	30 lbs.	\$ 358
	B-4	4' Angular Guard Rail	48"	1-5/16"	N/A	38 lbs.	\$ 386
	B-5	5'6" Angular Guard Rail	66"	1-5/16"	N/A	45 lbs.	\$ 422
	B-6	6' Angular Guard Rail	72"	1-5/16"	N/A	50 lbs.	\$ 428
	B-7	7' Angular Guard Rail	84"	1-5/16"	N/A	50 lbs.	\$ 438
	B-8	8' Angular Guard Rail	96"	1-5/16"	N/A	55 lbs.	\$ 475
	B-9	9' Angular Guard Rail	108"	1-5/16"	N/A	60 lbs.	\$ 504
		14" Extension Post	14"	1-5/16"	N/A	3 lbs.	\$ 33
		22" Extension Post	22"	1-5/16"	N/A	4 lbs.	\$ 35
		24" Extension Post	24"	1-5/16"	N/A	5 lbs.	\$ 35
		30" Extension Post	30"	1-5/16"	N/A	7 lbs.	\$ 37
		38" Extension Post	38"	1-5/16"	N/A	9 lbs.	\$ 41
		40" Extension Post	40"	1-5/16"	N/A	12 lbs.	\$ 42

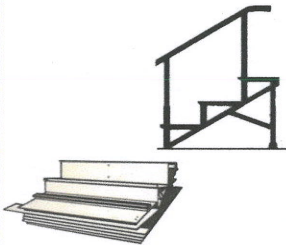
"KWIK-FOLD" STAIRS	Model	Desc.	Add Rails Two Sides	Depth	Width	Height	Weight	List Price
	KS216	2-Steps	[\$285 List/40 lbs.]	48"	22"	16"	75 lbs.	\$ 775
	KS324	3-Steps	[\$298 List/40 lbs.]	48"	31"	24"	85 lbs.	\$ 1,059
	KS432	4-Steps	[\$338 List/40 lbs.]	48"	41"	32"	105 lbs.	\$ 1,330
	KS540	5-Steps	[\$345 List/50 lbs.]	48"	50"	40"	135 lbs.	\$ 1,570
	KS542	5-Steps	[\$355 List/50 lbs.]	48"	53"	42"	145 lbs.	\$ 1,615
	KS648	6-Steps	[\$377 List/50 lbs.]	48"	60"	48"	155 lbs.	\$ 1,959
	KS756	7-Steps	[\$762 List/55 lbs.]	48"	69"	56"	175 lbs.	\$ 2,657
	KS864	8-Steps	[\$839 List/60 lbs.]	48"	78"	64"	195 lbs.	\$ 2,748
	KS972	9-Steps	[\$896 List/65 lbs.]	48"	88"	72"	210 lbs.	\$ 3,175

RAMPS	Model	Description	Length	Width	Height	Weight	List Price
	A48R-0008	Ground to 8" Height Inclining Deck	48"	96"	8"	145 lbs.	\$ 3,163
	B48R-0816	8" to 16" Height Inclining Deck	48"	96"	16"	155 lbs.	\$ 3,388
	C48R-1624	16" to 24" Height Inclining Deck	48"	96"	24"	170 lbs.	\$ 3,670
	D48R-2432	24" to 32" Height Inclining Deck	48"	96"	32"	180 lbs.	\$ 3,924
	E48R-3240	32" to 40" Height Inclining Deck	48"	96"	40"	200 lbs.	\$ 4,198
	F48R-4048	40" to 48" Height Inclining Deck	48"	96"	48"	226 lbs.	\$ 4,427

NOTE: Guard Rails are not included in above price. Consult with Mitchell Customer Service for recommendations of use.

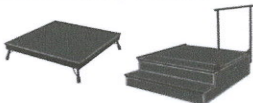
CONDUCTORS PODIA	Model	Description	Length	Width	Height	Weight	List Price
	P8	Directors Stand w/o Guard Rail	36"	36"	8"	50 lbs.	\$ 575
	P12	1 - Step Conductors Stand w/G.R.	48"	48"	12"	120 lbs.	\$ 1,563
	P16	2 - Step Conductor's Podium w/ G.R.	48"	58"	16"	210 lbs.	\$ 2,309

TRUCKS	Model	Description	Length	Width	Height	Weight	List Price
	T33	Flat Loading Truck - 12 Unit Capacity	41-1/4"	29-1/8"	85-3/4"	90 lbs.	\$ 1,114
	T35	Edge Loading Truck - 12 Unit Capacity	62"	34-3/4"	85-3/4"	150 lbs.	\$ 1,506

TRI-CORNER	Model	Description	Length	Width	Height	Weight	List Price
	T48	Use with 48" W Platforms for Added Set Design	48"	48"	8"	35 lbs.	\$ 475

Note: Consult Mitchell Customer Service for use and available sizes.



PO Box 1156
1700 W. St. Paul Avenue
Milwaukee, Wisconsin 53201
P. 414/342-3111 – 800/290-5960
F. 414/342-4239
www.mitchell-tables.com

Effective: January 1, 2017

GENERAL TERMS AND CONDITIONS

TERMS OF SALE - 30 days net to trade of established credit. No anticipation, no dating, 1½% per month service charge on overdue accounts. Where no credit is established, arrangements must be made regarding terms. All prices are F.O.B. Milwaukee, Wisconsin. without freight allowances.

ORDERS - All orders and contracts are subject to acceptance at Milwaukee, Wisconsin, and are contingent upon fires, strikes, accidents or other causes beyond our control. Shipments are made at purchaser's risk. All prices are quoted for immediate acceptance and are subject to change without notice. Prices prevailing at time of shipment must apply. Clerical errors are subject to correction.

PHONE ORDERS - "Confirmation" must follow immediately. Duplicate orders not marked or identified as "confirmation" are the responsibility of the customer.

ACKNOWLEDGEMENTS - Every order is acknowledged. Orders are manufactured and invoiced based upon the information in the acknowledgement. If there is any discrepancy, the dealer must notify Mitchell Furniture Systems within 5 working days. Orders are accepted by Mitchell Furniture Systems per terms herein and on the acknowledgement. Mitchell Furniture Systems rejects any terms and conditions contained in any customer purchase orders or other business forms which are different from the terms stated herein and on the acknowledgement.

SHIPMENT DAMAGE CLAIMS - All shipments should be carefully inspected by the consignee before acceptance and the delivering carrier should be requested to record any damage or shortage on the delivery receipt before the consignee signs it. If further damage is found after delivery, immediate inspection by the delivering carrier should be requested. Notification of concealed damages must be made to the delivering carrier within 15 days after delivery of

CAUTION: After obtaining a clear receipt for the shipment, the delivering carrier is no longer responsible for damage or shortages.

RETURNS - Merchandise returned will not be accepted without prior written consent of Mitchell Furniture Systems. After approval, returned merchandise must be shipped prepaid and subject to 50% handling charge unless it is Mitchell's responsibility.

WARRANTY - Mitchell Furniture Systems warrants products purchased hereunder to be free of defects in materials and workmanship for a period of fifteen (15) years parts and welds from the date of shipment. This warranty shall not apply in the event products are damaged as a result of misuse, abuse, neglect, accident, improper application, modification or repair by persons not authorized by Mitchell Furniture Systems, where products are damaged during shipment, or where date stamps on the products have been defaced, modified or removed. **UNLESS CONSIDERED UNENFORCEABLE OR UNLAWFUL UNDER APPLICABLE LAW.**

a. ALL IMPLIED WARRANTIES, INCLUDING BUT NOT LIMITED TO WARRANTIES OF MERCHANTABILITY AND FITNESS FOR A PARTICULAR PURPOSE ARE HEREBY EXCLUDED.

b. PURCHASER'S REMEDY, IF ANY, FOR ANY DEFECTIVE PRODUCTS SHALL BE LIMITED TO A REFUND, REPLACEMENT OR ADJUSTMENT BY MITCHELL FURNITURE SYSTEMS OF THE PRODUCTS AT MITCHELL FURNITURE SYSTEMS OPTION, AND SHALL IN NO EVENT INCLUDE DAMAGES OF ANY KIND, WHETHER INCIDENTAL, CONSEQUENTIAL OR OTHERWISE.

We reserve the right to make any changes in price, design and material specifications without notice.



MITCHELL

FURNITURE SYSTEMS



WITHSTAND THE TEST OF TIME

Many of our tables are still in use after 40 years. They last that long because we simply build them better.

MORE STEEL

Our tables have a solid feel because we use more steel. But it's not only the steel. It's the way we shape the steel and bend it to form the unitized design that allows our tables to stand up to rugged use.

BETTER ENGINEERING

Whether folding, rolling or locking, a Mitchell table does it better and with less effort. Our engineers design each feature with the highest quality component parts. This attention to quality ensures ease of use and long life.

FEATURES

- Unitized Design for easy maneuverability and control.
- Torsion Bars and Compression Springs for easy folding and unfolding.
- Positive Locks securely hold table in folded or unfolded position.

LOWEST COST TO OWN

Compare price. Compare quality. Mitchell offers you more value for the money.

TRUCKLOAD TO SPECIAL ORDERS

We can manufacture the tables you need. Call for more information.

CUSTOM FLOOR PLANS...NO CHARGE

We specialize in doing floor plans that optimize space. Call us with any layout problem and we can provide the solution at no charge.

P.O Box 1156

1700 West St. Paul Ave.

Milwaukee WI 53201

Phone: 414.342.3111

Toll Free: 800.290.5960

Fax: 414.342.4239

www.mitchell-tables.com



MITCHELL PORTABLES

These tables combine the best of superior engineering and compact design to provide maximum floor plan usage with minimum effort to setup.

All of these tables provide you with the following:

STANDARD FEATURES

- Easy Folding / Unfolding
 - Lock Securely in Folded / Unfolded Position
 - Compact Storage
 - Heavy-Duty Casters
 - Safe, Secure Seating
 - Wide Selection of Colors
 - Superior-Quality Parts
 - Scuff-Resistant Understructure
 - Scratch-Resistant Tops
 - Easy to Clean
 - Superior Construction
 - Rugged, Long-Lasting Durability
 - Lowest Total Owning Cost
 - Abundant Seating
-

For over a century, we have been providing our customers with quality products for a wide array of uses. No matter what your needs we have the table that is right for you.

P.O Box 1156

1700 West St. Paul Ave.

Milwaukee WI 53201

Phone: 414.342.3111

Toll Free: 800.290.5960

Fax: 414.342.4239

www.mitchell-tables.com

■ "08" SERIES WALL MOUNTED TABLES, BENCHES & STORAGE CABINETS

Our wall mounted table and bench systems provide the most efficient use of space in a cafeteria or multi-purpose room setting. Individual benches and tables can be used while attached to the cabinets or easily removed from the cabinets allowing you to set your room up to meet each activities needs.

Cabinets are available in a number of different configurations. Multiple depth units can store up to four tables and eight benches. Recessed or surface mounted cabinets along with a variety of bench and table dimensions are available allowing you to purchase a system that is appropriate for every room's environment, regardless of room size or capacity requirements.



Optional bench and table heights allow you to provide wheel chair accessibility throughout your cafeteria or multi-purpose room. Tables can be stored in any cabinet pocket of the same length or width allowing you to change the table and bench set ups to meet the needs of each event.



Wheel chair accesability available

DOUBLER TABLES

Length: 14' 13' 12' 10'

Width: 28" or 30"

Height: 25" 27" 29"

DOUBLER BENCHES

Length: 14' 13' 12' 10'

Width: 10" or 12"

Height: 15" 17" 20"

USES

Ideal for all cafeteria and multi-purpose room settings.





Automatic downlock



Hydraulic lift assist

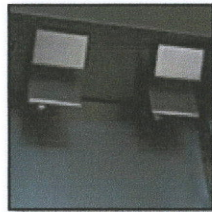

Double top lock

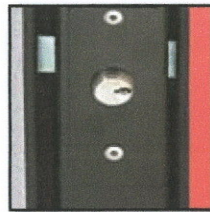

Keyed post lock

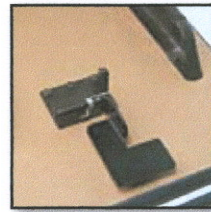

Storage lock



Each table and bench set has sixteen points of contact with the cabinet when stored. When combined with leaf to leaf storage locks, keyed post locks, automatic locking hinges and an anti-jackknife lift assist design, the "08" series is one of the safest and most secure in the industry.

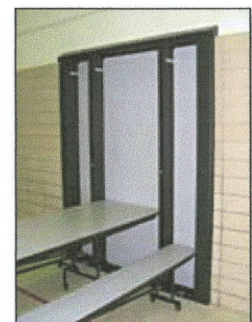
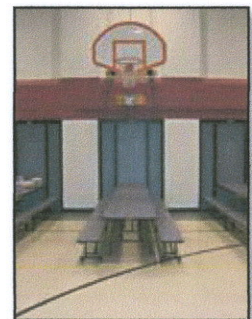
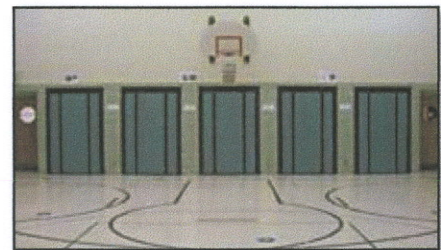

EASY OPEN
EASY FOLD





MITCHELL
FURNITURE SYSTEMS

Students find the NPX comfortable and inviting. Facility staff love the ease of folding, moving and cleaning around and under this table. The Business Office appreciates its affordability, longevity and low cost maintenance. The NPX is the table you'll want to have in your cafeteria.

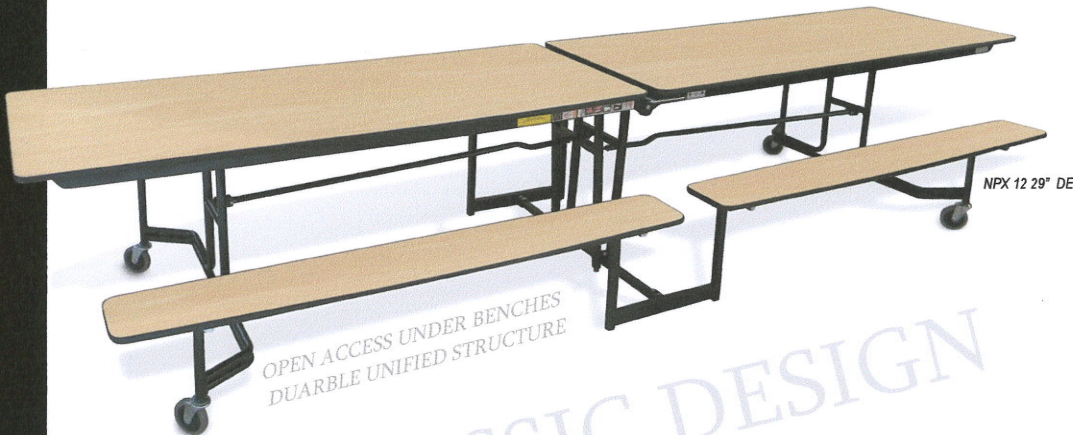

OPEN ACCESS UNDER BENCHES
DURABLE UNIFIED STRUCTURE

CLASSIC DESIGN



SPACIOUS SUPER LIFT ASSISTS DURABLE

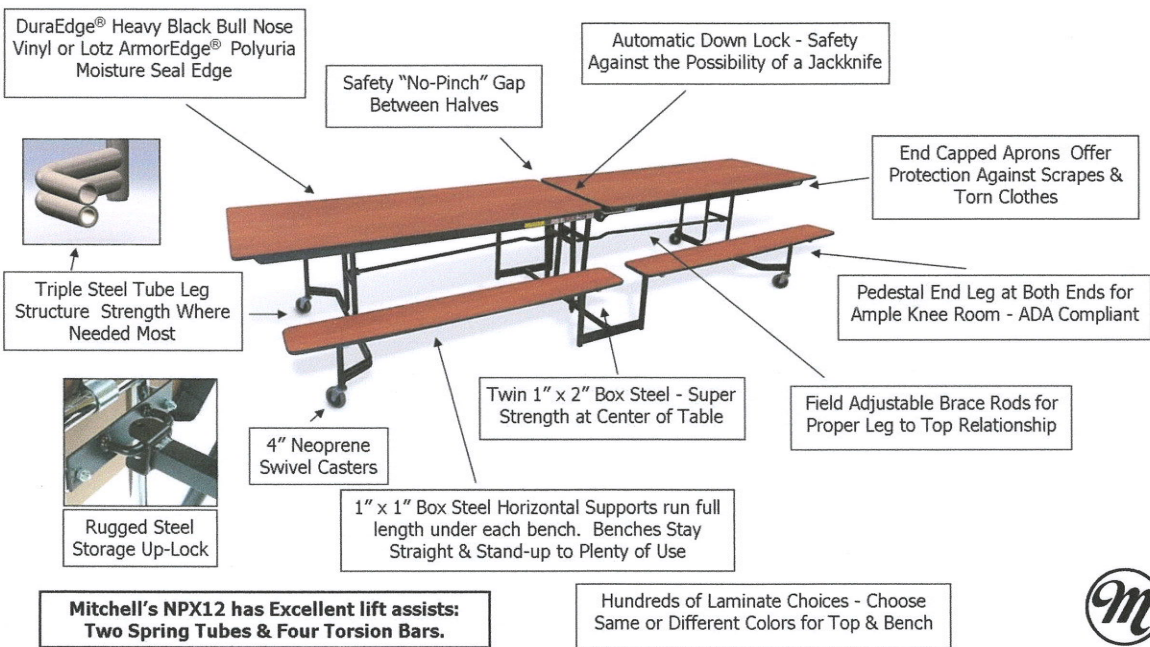

SPECIFICATIONS

Table Top Supports

Two full length, 1-3/4" D x 16-gauge cold rolled steel apron channels with rounded edges and dressed off end fittings for safety.

Twin Dual Center Legs

1" x 1" 16-gauge box tubing at the center of the table provides positive, direct support for each half of the table top.

End Legs

Consists of three tubes for rigid, long lasting strength. One is welded on top, the bottom tube has an extra tube inside. Outer tubes have minimum wall thickness of .072".

Seating

Benches are 9-1/2" x 64" and are positioned at 17" H, each of the four benches provide proper knee clearance from understructure.

Table & Seat Tops

Table tops, bench tops are made with 45lbs density particleboard core with high pressure laminated top, balanced with durable Gator™ black backer. Tops are edged with Mitchell custom DuraEdge™ a heavy polyvinyl, extended bullnose for maximum bump protection and moisture barrier, or Lotz ArmorEdge™ the original Polyurea black moisture retardant edge (MDF core.)

Fasteners

Tops are attached with full threaded, hex head screws with a minimum holding power of 300lbs. Each fastener is machine driven and seated. The hex head permits normal maintenance of units if required.

Locks

Steel uplocks automatically engage when table's folded and manually release for user position. Downlock engages automatically to prevent the possibility of a jackingknife; manual release is accessible from both sides of the table.

Unitized Construction

Welded steel brackets and fittings solidly join and position legs to channel support aprons and anchor the torsion bar lift assists.

Lift Assists

Industry best dual lift assists, both concealed torsion bars and extension springs for easy operation throughout the use of the table.

Finish

End legs are available in either Black Epoxy Powder Coat or Nickel Chromium. The understructure is black powder coat.

ADA - NPX Retro Kit

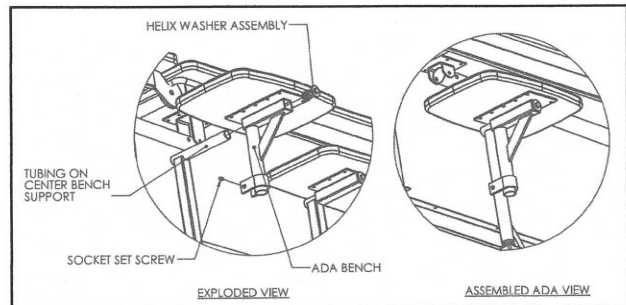
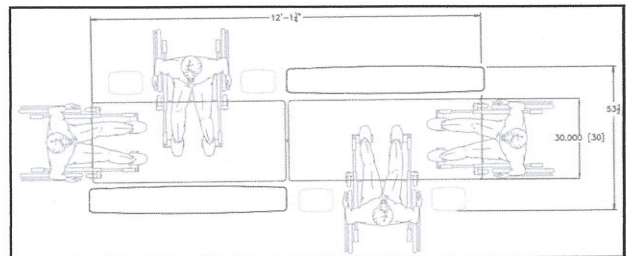

Section 902 of the 2010 ADA Standards requires 5% of the cafeteria space to be compliant. ADA tables are 28" to 34" H, have knee clearance of 27" H x 19" D and provide a 30" W serving surface. NPX12 end legs are recessed and meet these standards. In addition by simply removing a side bench and using our ADA Retro Kit (Model # 67-098) students can sit along the side of the table as well. Please contact Mitchell Customer Service for more information 800/290-5960.



Tamper resistant steel storage up-lock.

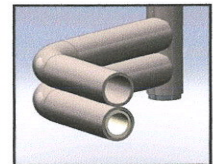
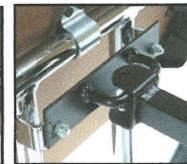

Triple steel tube end leg.

Long Lasting Quality

MODEL #	NPX12 29 DE	NPX12 27 DE	NPX12 29 AE	NPX12 27 AE
Storage Dimensions	52.5" W x 31" D x 79.5" H	52.5" W x 31" D x 77.5" H	52.5" W x 31" D x 79.5" H	52.5" W x 31" D x 77.5" H
Seating Capacity	16-18	16-18	16-18	16-18
Bench/Seat Size	9-1/2" x 64"	9-1/2" x 64"	9-1/2" x 64"	9-1/2" x 64"
Black Edge	Custom DuraEdge™	Custom DuraEdge™	Lotz ArmorEdge™	Lotz ArmorEdge™
Table Height Choices	29"	27"	29"	27"



Down-lock has heavy-duty release handle that automatically locks the two halves of the table at the hinge.



MITCHELL
FURNITURE SYSTEMS



NP 12/16 OR GP 12/16

This table features individual seats and powder coated understructure. GP tables have a combination of nickel-chromium plated and powder coated understructure, with stainless steel scuff plates.

SELECTION

- Lengths: 12' 10' 8'
- Seats: 16
- Tops: 30" wide
- Height: 27" or 29"
- Colors: Mix and match

UNFOLDED DIMENSIONS

- Length Overall: 12' 1"
- Width: 53 1/2"
- Table & Bench Heights: 29"/17" or 27"/17"

COMPACT FOLDED DIMENSIONS

- 12' Unit
- Length Overall: 53 1/2"
- Width: 34"
- Height: 29"/17", 80 5/8"
- Nested Storage: 9 1/2 sq ft.

USES

Cafeterias, multi-purpose areas

Includes Standard PorTable Features

In addition to the tables shown, the NP and GP series of tables are also available in: 8' length with 8 seats • 10' length with 12 seats • 12' length with 12 seats.

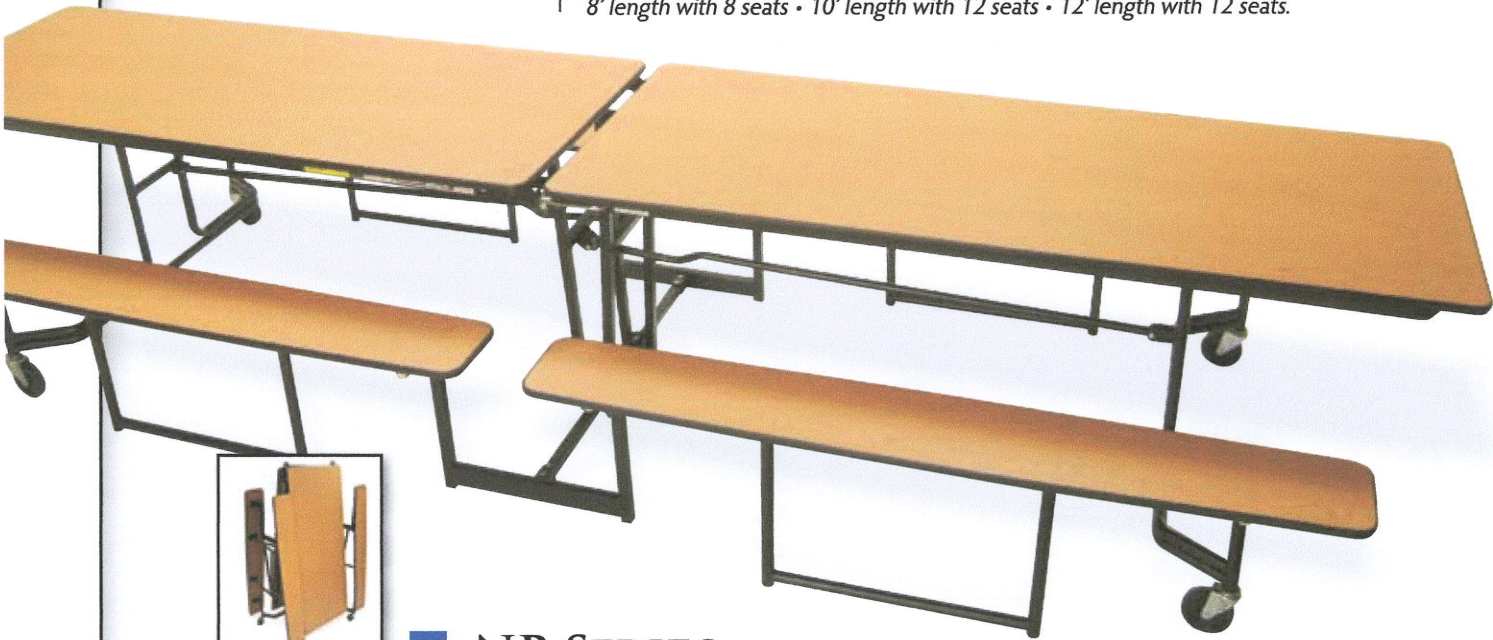

NP SERIES





QUALITY
LONG-LASTING PRODUCTS

GP SERIES

This table features multiple twin seating and a combination of nickel-chromium-plated and powder coated understructure. Solid-core high pressure laminated tops assure long-lasting quality.

SELECTION

Lengths: 12' 10' 8'
Tops: 30" wide
Height: 27" or 29"
Colors: Mix and match

UNFOLDED DIMENSIONS 12' UNIT

Length Overall: 12' 1"
Width: 53 1/2"
Table & Bench Heights: 29"/17" or 27"/17"

COMPACT FOLDED DIMENSIONS

12' Unit
Length Overall: 53 1/2 "
Width: 34" Height, 80 5/8"
Nested Storage: 9 1/2 sq ft.

USES

Cafeterias, multi-purpose areas

Includes Standard PorTable Features



Heavy-duty release handle for locking hinge. Automatic locking hinge.

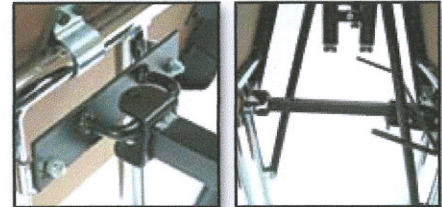

Tamper resistant storage lock.

NP SERIES

This table features a bench design for convenient center accessibility. Heavy gauge round and rectangular tubing provides structural safety in attractive midnight-brown metal finish.

SELECTION

Lengths: 12' 10' 8'
Tops: 30" wide
Height: 27" or 29"
Colors: Mix and match

UNFOLDED DIMENSIONS 12' UNIT

Length Overall: 12' 1"
Width: 53 1/2"
Table & Bench Heights: 29"/17" or 27"/17"

COMPACT FOLDED DIMENSIONS

12' UNIT
Length Overall: 53 1/2 "
Width: 34" Height, 80 5/8"
Nested Storage: 9 1/2 sq ft.

USES

Cafeterias, multi-purpose areas

Includes Standard PorTable Features



UNIQUE SHAPE

PROVIDES MORE SEATING



ST-4872 PORTABLES

This table's unique shape provides more seating in the same area than conventional tables and chairs. It rolls through standard doors in its storage position. End legs and center bench supports are nickel-chrome. All other metal parts are powder coated.

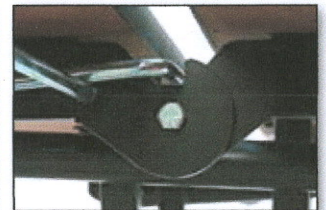
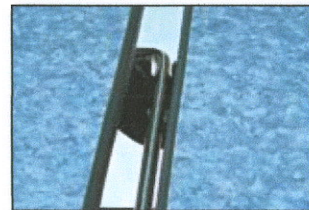

Locks: Unique dual-purpose lock holds table securely in both up and down position. It is easily reached from both sides of the table.

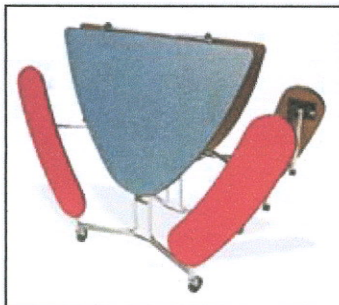

DESCRIPTION

Shape: Curved 48" X 72"
Height: 27" or 29"
Bench Seats: 40" X 10" with
 10" rounded ends
Seating: 17"

CONSTRUCTION

Center legs: 16 gauge 1" X 1" square tubing.

Tabletop supports:

Two full-length, 16-gauge cold steel apron channels.

Unitized: welded steel brackets and fittings.

USES

Cafeteria, multi-purpose area

Includes Standard PorTable Features



CONVERTABLE BENCH TABLES

The most versatile product we make turns any room into a cafeteria, auditorium, classroom or recreation room. Use your imagination to configure the room you want. End-leg assemblies are nickel-chrome plated. All other parts are powder coated.

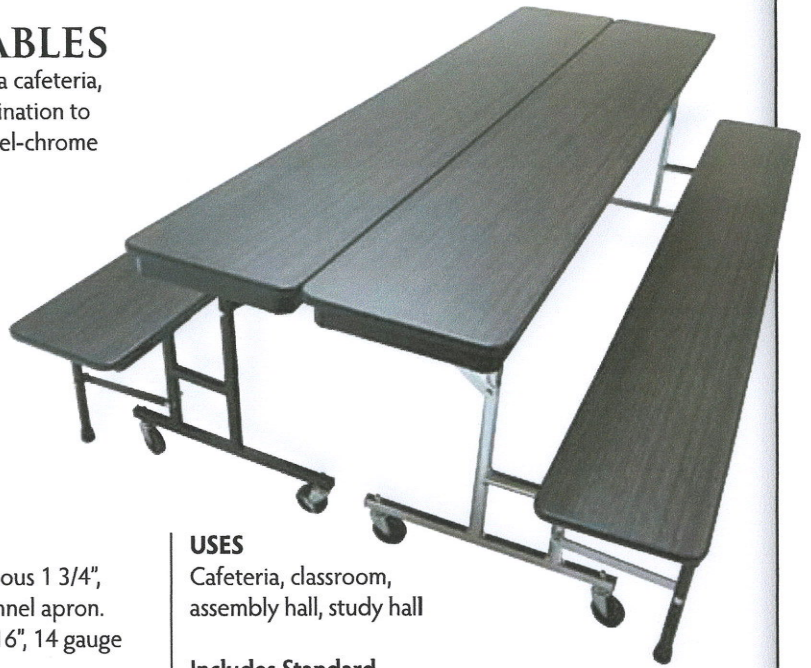
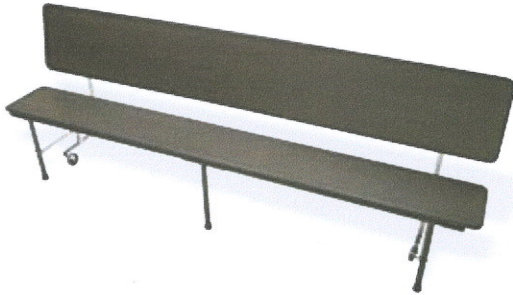

GENERAL

Length: 6' 7" 8"
Height: Tabletop 29"
 bench 17"
Width: Tabletop 15"
 bench 12"

CONSTRUCTION

Tabletop support: continuous 1 3/4",
 16-gauge cold rolled channel apron.
Bench support: three 1 1/16", 14 gauge
 steel legs.
End legs: all-welded 1 1/4", 14 gauge
 steel tubing.

USES

Cafeteria, classroom,
 assembly hall, study hall

**Includes Standard
 PorTable Features**

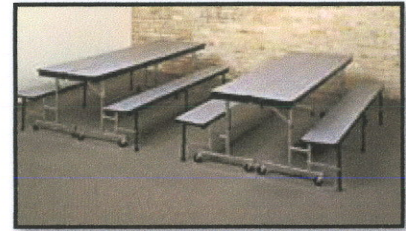

VERSATILE
 CONFIGURATIONS



FOLD-N-ROLL TABLES

These tables feature automatic lift-off supports, which firmly hold the table in place when in an open position. Height adjustment locks securely in all positions. Safety locks prevent finger pinching. Available with chrome or powder coated legs. Fixed and adjustable heights available.

USES

Conferences, classrooms, meetings
Low height adjustment for kindergarten and church schools

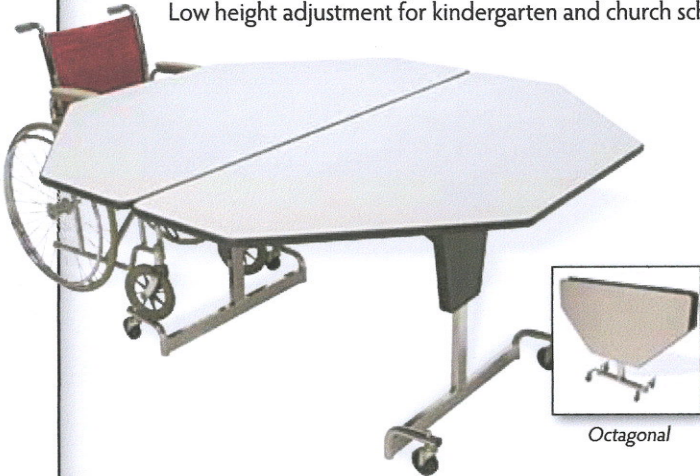

AVAILABLE SIZES

48" Round
48" Hexagon
48" Square
60" Round
60" Octagon
72" Round

ADJUSTABLE HEIGHT

22" to 29" 29" to 36"
22" to 29" 29" to 36"
22" to 29" 29" to 36"
22" to 29" 29" to 36"
22" to 29" 29" to 36"
NA

FIXED HEIGHT

27" or 29"
27" or 29"
27" or 29"
27" or 29"
27" or 29"
27" or 29"

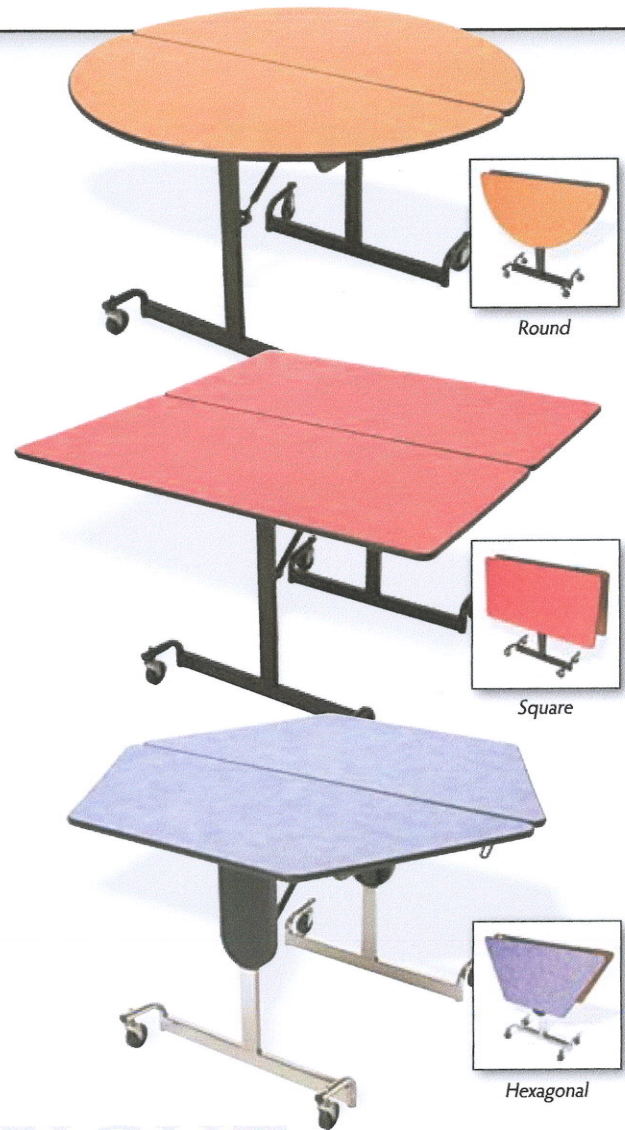

ADJUSTABLE HEIGHT
SAFETY LOCKS

OVAL TABLES

Both of these tables are ideal for meetings where maximum seating capacity and work area are required. Each features caster lift-offs to hold firmly in place and two-stage safety locks. Available in chrome or powder coated legs. Fixed and adjustable heights available.



OVAL TABLE SIZES

60" X 66" or 60" X 72" or 48" X 72"

Height: Fixed 27" or 29"

Height: Adjustable from 22" to 29" in one-inch increments

FOLD-N-ROLL SEMINAR AND TRAINING TABLES

As the name implies, these tables are designed for those meetings that require optimum use of space for each person seated at the table. Available in fixed or multi-height adjustable models.

OPTIMUM
USE OF SPACE

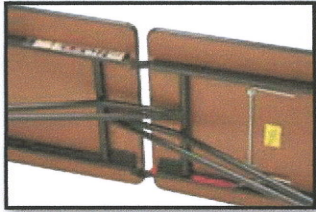
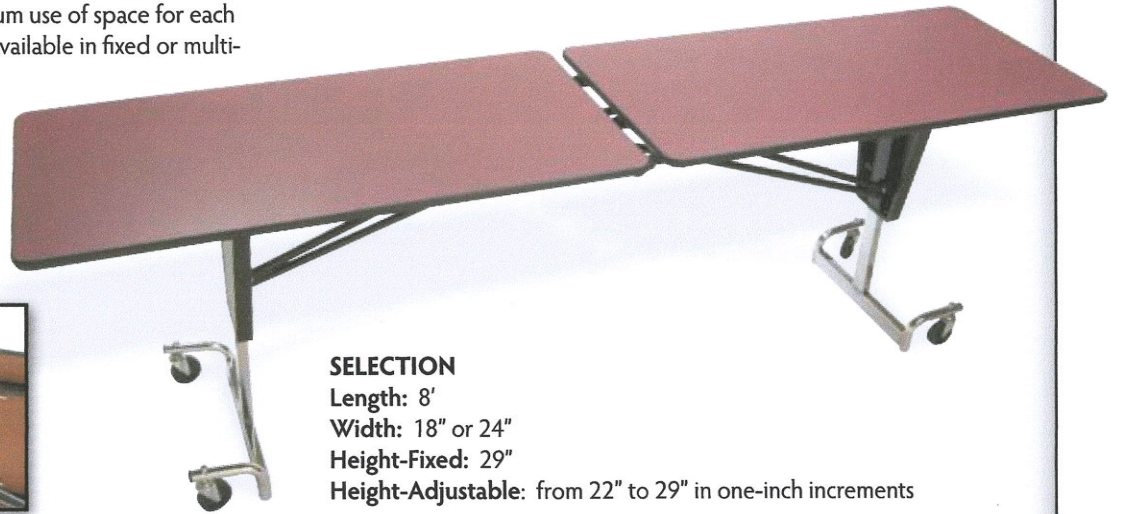

Dual brace rod eliminates the center leg creating more seating space.

SELECTION

Length: 8'

Width: 18" or 24"

Height-Fixed: 29"

Height-Adjustable: from 22" to 29" in one-inch increments

UNITABLES

This rugged multi-purpose table offers an unlimited number of uses. Metal parts available with nickel-chrome-plating or powder coated finish. Fully enclosed torsion bars make for easy folding and unfolding. In the open position, four anchor pads firmly hold the table in position.

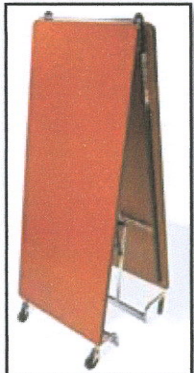
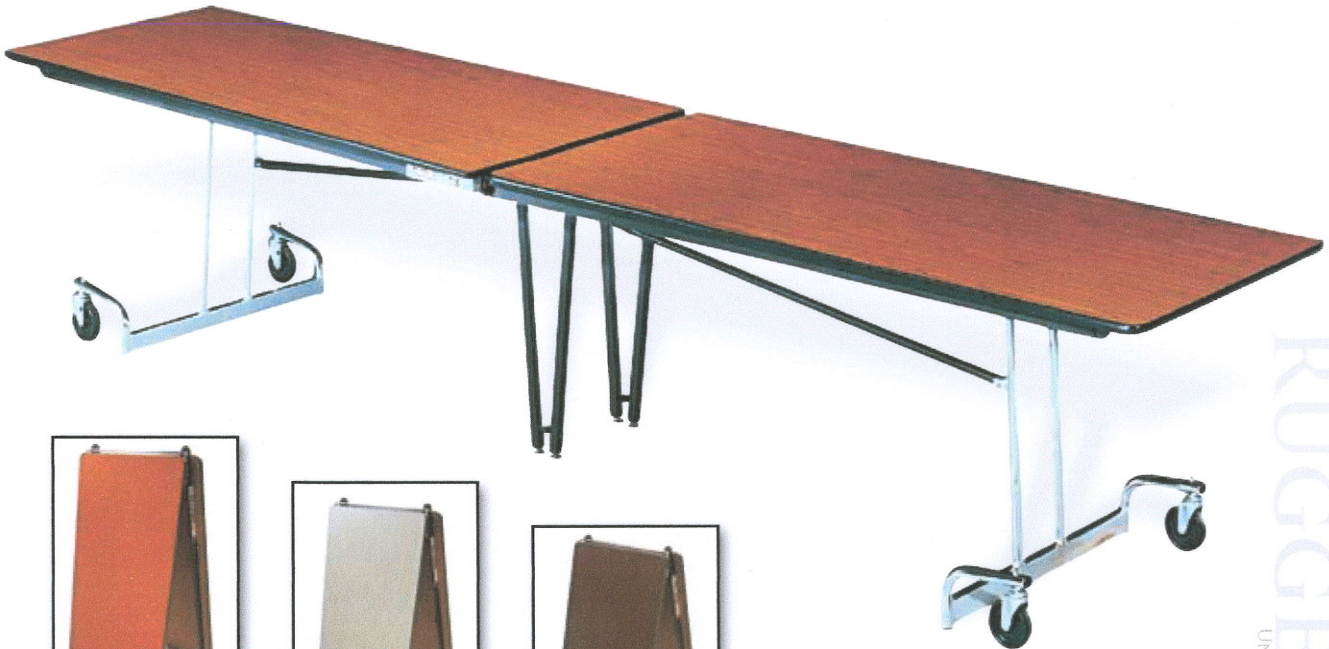

Dun12 (Chrome leg)



WO-10



Dun12 (Chrome leg)

RUGGED
UNLIMITED USES

SELECTION

Length: 8' 10' or 12'

Width: 30"

Height : 27" or 29"

Folded Height: 12' Unit — 79 1/2"



FOLD-O-LEG TABLES

These heavy-duty, 29" high tables feature our patented Jack-Knife folding brace, which eliminates rattle and adds stability. A simple, strong compression spring allows easy opening and folding. All metal parts are heavy-gauge high-carbon steel, cold formed and rolled, and a powder coated finish.

SIZES

Length: 36" to 96"

Width: 18" to 36"



HEAVY-DUTY

EASY OPEN AND FOLDING

SATURNA FOLDING TABLES

You cannot buy a better table. This is our top of the line table featuring a tough, non-mar top and floor glides, inverted "T" folding pedestal base for stability and strength with a nickel-chromium finish. The support frame is tough, cold rolled steel with a powder coated finish. A bullnose edging of heavy contoured vinyl plastic protects the edges.

SIZES

Length: 36" to 96"

Width: 18" to 36"

ADJUSTABLE HEIGHT

From 22" to 29" in 1" increments

From 29" to 36" in 1" increments

USES

Libraries, churches, offices, clubs, classroom or study hall

ROUND TABLE SIZES

48" and 60" diameter

TRAPEZOID TABLE SIZES

48" X 72" with 30" ends



TOUGH

STABLE AND STRONG

650 SERIES SEMINAR FIXED HEIGHT FOLDING TABLE

Ideally suited for classroom, conference or lecture hall. Available in powder coated or chrome end legs.

SIZES

Length: 60" 72" 96"

Width: 18" 24"

Height: 27" or 29"



QUICK & EASY

SETUP & TAKE DOWN



FOLD-O-LEG STAGES / STANDS / RISERS

Our portable folding systems provide easy, fast, safe and flexible setup for your entertainment and professional events. The stage, riser and platform units are only 2 1/2" thick when folded. A complete 70-piece orchestra requires a 4' W X 8'L X 5'H storage area. Available with portable folding stairs, guardrails and enclosure panels.

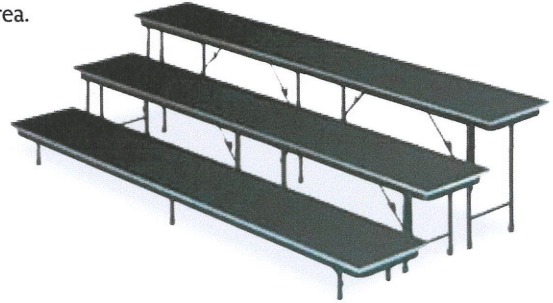

FEATURES

- Standard 8' X 4' units produce one-level platforms or stages.
- Multi-level stage arrangements for seating and bands.
- Tapered risers clamp securely together.

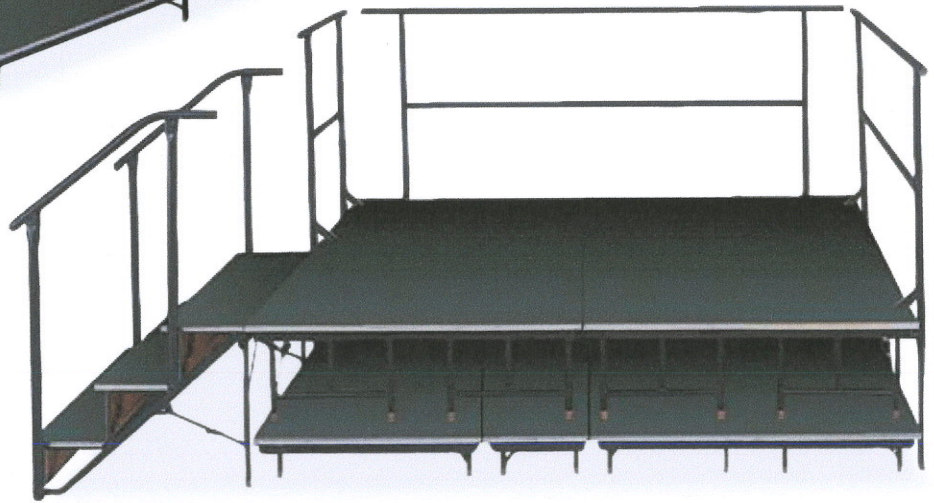

PORTABLE
FAST, SAFE, AND FLEXIBLE SETUP

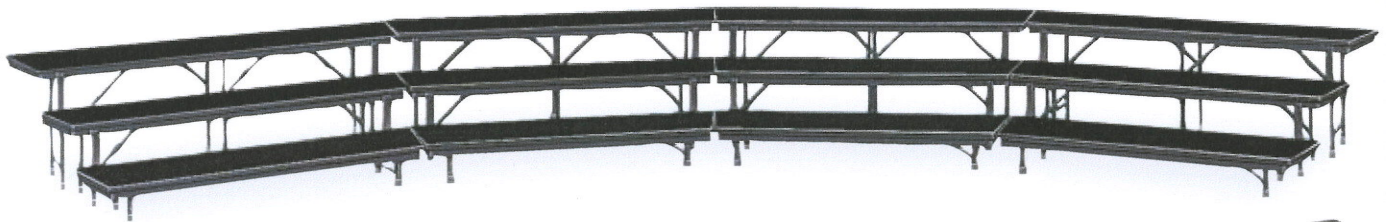

FOLD-O-LEG TABLE AND RISER TRUCKS

These trucks are designed for heavy-duty use and a lifetime of trouble-free service. They are made of steel tubing welded into a complete unit. Each is equipped with removable handles. Two wheels swivel for turning in confined areas. Flat Loading/Risers and Rectangular Tables.



*Flat Loading will carry
up to 12 tables.*



MITCHELL
FURNITURE SYSTEMS

P.O Box 1156 • 1700 West St. Paul Ave. • Milwaukee WI 53201
Phone: 414.342.3111 • Toll Free: 800.290.5960 • Fax: 414.342.4239
www.mitchell-tables.com